

# Laboratory



**Muffle Furnaces**  
**Preheating Furnaces**  
**Ashing Furnaces**  
**Tube Furnaces**  
**Ovens**  
**Air Circulation Furnaces**  
**Chamber Furnaces**  
**Melting Furnaces**  
**High-Temperature Furnaces**  
**Retort Furnaces**  
**Vacuum Furnaces**  
**Brazing Furnaces**  
**Clean Room Furnaces**

[www.nabertherm.com](http://www.nabertherm.com)

■ Made  
■ in  
■ Germany



### **Made in Germany**

Nabertherm with 450 employees worldwide have been developing and producing industrial furnaces for many different applications for over 60 years. As a manufacturer, Nabertherm offers the widest and deepest range of furnaces worldwide. 150,000 satisfied customers in more than 100 countries offer proof of our commitment to excellent design, quality and cost efficiency. Short delivery times are ensured due to our complete inhouse production and our wide variety of standard furnaces.

### **Setting Standards in Quality and Reliability**

Nabertherm does not only offer the widest range of standard furnaces. Professional engineering in combination with inhouse manufacturing provide for individual project planning and construction of tailor-made thermal process plants with material handling and charging systems. Complete thermal processes are realized by customized system solutions.

Innovative Nabertherm control technology provides for precise control as well as full documentation and remote monitoring of your processes. Our engineers apply state-of-the-art technology to improve the temperature uniformity, energy efficiency, reliability and durability of our systems with the goal of enhancing your competitive edge.

### **Global Sales and Service Network – Close to you**

Nabertherm's strength is one of the biggest R&D department in the furnace industry. In combination with central manufacturing in Germany and decentralized sales and service close to the customer we can provide for a competitive edge to live up to your needs. Long term sales and distribution partners in all important world markets ensure individual on-site customer service and consultation. There are various reference customers in your neighborhood who have similar furnaces or systems.

### **Large Customer Test Center**

What furnace is the right choice for this specific process? This question cannot always be answered easily. Therefore, we have set up our modern test center which is unique in respect to size and variety. A representative number of furnaces is available for tests for our customers.

### **Customer Service and Spare Parts**

Our professional service engineers are available for you worldwide. Due to our complete inhouse production, we can despatch most spare parts from stock over night or produce with short delivery time.



### **Experience in Many Fields of Thermal Processing**

In addition to furnaces for laboratory, Nabertherm offers a wide range of standard furnaces and plants for many other thermal processing applications. The modular design of our products provides for customized solutions to you individual needs without expensive modifications.

## Table of Contents

	Page
<b>Muffle/Preheating/Ashing Furnaces and Accessories</b> .....	4
Weighing furnace incl. scale and software for determination of combustion loss up to 1200 °C.....	11
Exhaust systems/Accessories.....	12
<b>Assay Furnaces up to 1300 °C</b> .....	13
<b>Annealing, Hardening and Brazing Furnaces with Accessories</b> .....	14
<b>Chamber Furnaces with Brick Insulation or Fiber Insulation up to 1400 °C</b> .....	16
<b>High-Temperature Furnaces/Sintering Furnaces</b>	
High-temperature furnaces with SiC rod heating up to 1600 °C.....	18
High-temperature furnaces with MoSi <sub>2</sub> heating elements up to 1800 °C.....	19
High-temperature furnaces lift-bottom up to 1700 °C .....	20
High-temperature furnaces with scale for determination of combustion loss and thermogravimetric analysis (TGA) up to 1750 °C.....	21
High-temperature furnaces with fiber insulation up to 1800 °C .....	22
High-temperature furnaces with SiC rod heating up to 1550 °C.....	24
High-temperature furnaces with refractory brick insulation up to 1700 °C .....	25
<b>Ovens and Air Circulation Furnaces</b> .....	26
<b>Clean Room Solutions</b> .....	29
<b>Tube Furnaces and Accessories</b>	
Compact tube furnaces up to 1300 °C.....	30
Tube furnaces with stand for horizontal or vertical operation up to 1500 °C.....	32
High-temperature tube furnaces with SiC rod heating up to 1500 °C, gas atmosphere or vacuum.....	33
High-temperature tube furnaces for horizontal and vertical operation up to 1800 °C, gas atmosphere or vacuum.....	34
Split-type tube furnaces for horizontal or vertical operation up to 1300 °C, gas atmosphere or vacuum.....	36
Rotary tube furnaces for batch operation up to 1100 °C .....	38
Rotary tube furnaces for continuous processes up to 1300 °C .....	40
Working tubes for rotary tube furnaces: standard and options .....	42
Working tubes: standard and options.....	43
Gas supply systems/vacuum operation for tube furnaces.....	44
Vacuum pumps .....	45
Control alternatives for tube furnaces .....	46
Customized tube furnaces .....	47
<b>Melting Furnaces up to 1500 °C</b> .....	48
<b>Fast-Firing Furnaces up to 1300 °C</b> .....	49
<b>Gradient or Lab Strand Annealing Furnaces up to 1300 °C</b> .....	49
<b>Retort Furnaces</b>	
Hot-wall retort furnaces up to 1100 °C.....	50
Cold-wall retort furnaces up to 2400 °C or up to 3000 °C.....	53
Cold-wall retort furnaces up to 2400 °C.....	54
<b>Catalytic and Thermal Afterburning Systems, Exhaust Gas Washer</b> .....	58
<b>Temperature Uniformity and System Accuracy</b> .....	59
<b>Process Control and Documentation</b> .....	60



## Muffle Furnaces with Flap Door or Lift Door



L 3/12



L 5/11

### L 1/12 - LT 40/12

The muffle furnaces L 1/12 - LT 40/12 are the right choice for daily laboratory use. These models stand out for their excellent workmanship, advanced and attractive design, and high level of reliability. The muffle furnaces come equipped with either a flap door or lift door at no extra charge.

- Tmax 1100 °C or 1200 °C
- Heating from two sides by ceramic heating plates (heating from three sides for muffle furnaces L 24/11 - LT 40/12)
- Ceramic heating plates with integral heating element which is safeguarded against fumes and splashing, and easy to replace
- Insulation made of non-classified fiber material
- Housing made of sheets of textured stainless steel
- Dual shell housing for low external temperatures and high stability
- Optional flap door (L) which can be used as work platform or lift door (LT) with hot surface facing away from the operator
- Adjustable air inlet integrated in door (see illustration)
- Exhaust air outlet in rear wall of furnace
- Solid state relays provide for low-noise operation
- Defined application within the constraints of the operating instructions
- Controls description see page 60

### Additional equipment

- Chimney, chimney with fan or catalytic converter (not for L 1)
- Over-temperature limiter with adjustable cutout temperature for thermal protection class 2 in accordance with EN 60519-2 as temperature limiter to protect the furnace and load
- Protective gas connection to purge with non-flammable protective or reaction gases
- Manual or automatic gas supply system
- Please see page 12 for more accessories
- Process control and documentation with Controltherm MV software package see page 63



Over-temperature limiter





LT 3/11



LT 5/12

Model	Tmax Flap door °C	Inner dimensions in mm			Volume in l	Outer dimensions in mm			Connected load kW	Electrical connection*	Weight in kg	Minutes to Tmax <sup>2</sup>
		w	d	h		W	D	H				
L 3/11	1100	160	140	100	3	380	370	420	1.2	1-phase	20	60
L 5/11	1100	200	170	130	5	440	470	520	2.4	1-phase	35	60
L 9/11	1100	230	240	170	9	480	550	570	3.0	1-phase	45	75
L 15/11	1100	230	340	170	15	480	650	570	3.5	1-phase	55	90
L 24/11	1100	280	340	250	24	560	660	650	4.5	3-phase	75	95
L 40/11	1100	320	490	250	40	600	790	650	6.0	3-phase	95	95
L 1/12	1200	90	115	110	1	250	265	340	1.5	1-phase	10	25
L 3/12	1200	160	140	100	3	380	370	420	1.2	1-phase	20	75
L 5/12	1200	200	170	130	5	440	470	520	2.4	1-phase	35	75
L 9/12	1200	230	240	170	9	480	550	570	3.0	1-phase	45	90
L 15/12	1200	230	340	170	15	480	650	570	3.5	1-phase	55	105
L 24/12	1200	280	340	250	24	560	660	650	4.5	3-phase	75	110
L 40/12	1200	320	490	250	40	600	790	650	6.0	3-phase	95	110



Muffle furnace L 5/11 with gas supply system

Model	Tmax Lift door °C	Inner dimensions in mm			Volume in l	Outer dimensions in mm			Connected load kW	Electrical connection*	Weight in kg	Minutes to Tmax <sup>2</sup>
		w	d	h		W	D	H <sup>1</sup>				
LT 3/11	1100	160	140	100	3	380	370	420+165	1.2	1-phase	20	60
LT 5/11	1100	200	170	130	5	440	470	520+220	2.4	1-phase	35	60
LT 9/11	1100	230	240	170	9	480	550	570+290	3.0	1-phase	45	75
LT 15/11	1100	230	340	170	15	480	650	570+290	3.5	1-phase	55	90
LT 24/11	1100	280	340	250	24	560	660	650+335	4.5	3-phase	75	95
LT 40/11	1100	320	490	250	40	600	790	650+335	6.0	3-phase	95	95
LT 3/12	1200	160	140	100	3	380	370	420+165	1.2	1-phase	20	75
LT 5/12	1200	200	170	130	5	440	470	520+220	2.4	1-phase	35	75
LT 9/12	1200	230	240	170	9	480	550	570+290	3.0	1-phase	45	90
LT 15/12	1200	230	340	170	15	480	650	570+290	3.5	1-phase	55	105
LT 24/12	1200	280	340	250	24	560	660	650+335	4.5	3-phase	75	110
LT 40/12	1200	320	490	250	40	600	790	650+335	6.0	3-phase	95	110



Adjustable air inlet integrated in the door

<sup>1</sup>Including opened lift door

<sup>2</sup>If connected at 230 V 1/N/PE resp. 400 V 3/N/PE

\*Please see page 60 for more information about supply voltage

## Muffle Furnaces Basic Models



LE 1/11



LE 6/11

### LE 1/11 - LE 14/11

With their unbeatable price/performance ratio, these compact muffle furnaces are perfect for many applications in the laboratory. Quality features like the dual shell furnace housing of rust-free stainless steel, their compact, lightweight constructions, or the heating elements encased in quartz glass tubes make these models reliable partners for your application.

- Tmax 1100 °C, working temperature 1050 °C
- Heating from two sides from heating elements in quartz glass tubes
- Maintenance-friendly replacement of heating elements and insulation
- Insulation made of non-classified fiber material
- Housing made of sheets of textured stainless steel
- Dual shell housing for low external temperatures and high stability
- Flap door which can also be used as a work platform
- Exhaust air outlet in rear wall
- Solid state relays provide for low-noise operation
- Compact dimensions and light weight
- Controller mounted under the door to save space
- Defined application within the constraints of the operating instructions
- Controls description see page 60



Over-temperature limiter

### Additional equipment

- Chimney, chimney with fan or catalytic converter (not for L 1)
- Over-temperature limiter with adjustable cutout temperature for thermal protection class 2 in accordance with EN 60519-2 as temperature limiter to protect the furnace and load
- Protective gas connection to purge with non-flammable protective or reaction gases
- Manual gas supply system
- Please see page 12 for more accessories
- Process control and documentation with Controltherm MV software package see page 63

Model	Tmax °C	Inner dimensions in mm			Volume in.l	Outer dimensions in mm			Connected load kW	Electrical connection*	Weight in kg	Minutes to Tmax <sup>1</sup>
		w	d	h		W	D	H				
LE 1/11	1100	90	115	110	1	250	265	340	1.5	1-phase	10	10
LE 2/11	1100	110	180	110	2	275	380	350	1.8	1-phase	10	25
LE 6/11	1100	170	200	170	6	510	400	320	1.8	1-phase	18	35
LE 14/11	1100	220	300	220	14	555	500	370	2.9	1-phase	25	40

<sup>1</sup>If connected at 230 V 1/N/PE resp. 400 V 3/N/PE

\*Please see page 60 for more information about supply voltage

## Muffle Furnaces with Brick Insulation and Flap Door or Lift Door



LT 5/13



L 9/13

### L 5/13 - LT 15/13

Heating elements on support tubes radiating freely into the furnace chamber provide for particularly short heating times for these muffle furnaces. Thanks to their robust lightweight refractory brick insulation, they can reach a maximum working temperature of 1300 °C. These muffle furnaces thus represent an interesting alternative to the familiar L(T) 3/11 models, when you need particularly short heating times or a higher application temperature.

- Tmax 1300 °C
- Heating from two sides
- Heating elements on support tubes ensure free heat radiation and a long service life
- Multi-layer insulation with robust lightweight refractory bricks in the furnace chamber
- Housing made of sheets of textured stainless steel
- Dual shell housing for low external temperatures and stability
- Optional flap door (L) which can be used as work platform or lift door (LT) with hot surface facing away from the operator
- Adjustable air inlet in the furnace door
- Exhaust air outlet in rear wall of furnace
- Solid state relays provide for low-noise operation
- Defined application within the constraints of the operating instructions
- Controls description see page 60



Furnace lining with high-quality lightweight refractory brick insulation

### Additional equipment

- Chimney, chimney with fan or catalytic converter
- Over-temperature limiter with adjustable cutout temperature for thermal protection class 2 in accordance with EN 60519-2 as temperature limiter to protect the furnace and load
- Protective gas connection to purge with non-flammable protective or reaction gases
- Manual or automatic gas supply system
- Please see page 12 for more accessories



Over-temperature limiter

Model	Tmax °C	Inner dimensions in mm			Volume in l	Outer dimensions in mm			Connected load kW	Electrical connection*	Weight in kg	Minutes to Tmax <sup>2</sup>
		w	d	h		W	D	H				
L, LT 5/13	1300	200	170	130	5	440	470	520+220 <sup>1</sup>	2.4	1-phase	42	45
L, LT 9/13	1300	230	240	170	9	480	550	570+290 <sup>1</sup>	3.0	1-phase	60	50
L, LT 15/13	1300	230	340	170	15	480	650	570+290 <sup>1</sup>	3.5	1-phase	70	60

<sup>1</sup>Including opened lift door (LT models)

<sup>2</sup>If connected at 230 V 1/N/PE resp. 400 V 3/N/PE

\*Please see page 60 for more information about supply voltage

## Ashing Furnaces with Flap Door or Lift Door

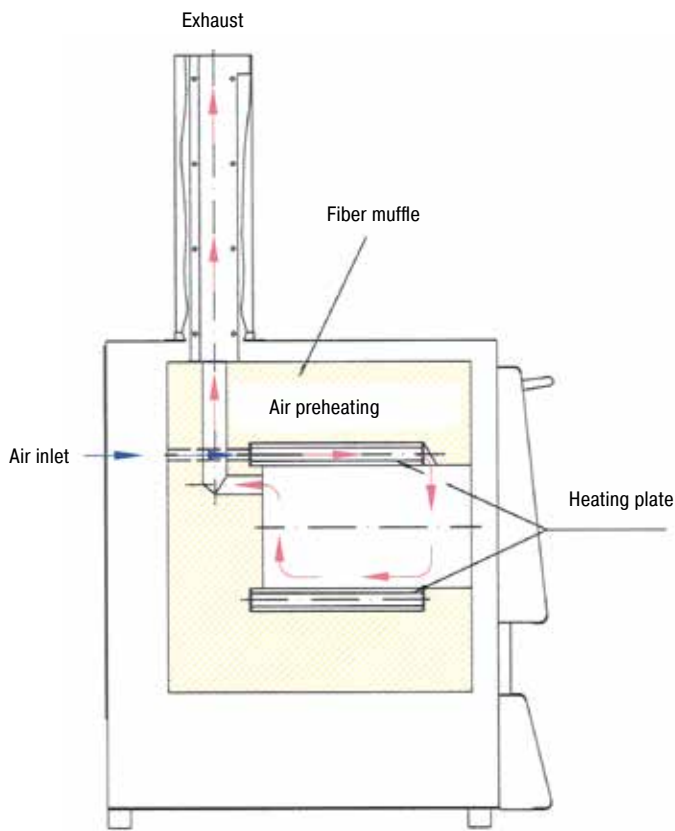

Air intake and exhaust flow principle



LV 3/11

### LV 3/11 - LVT 15/11

The ashing furnaces LV 3/11 - LVT 15/11 are especially designed for ashing in the laboratory. A special air intake and exhaust system allows air exchange of more than 6 times per minute. Incoming air is preheated to ensure a good temperature uniformity.

- Tmax 1100 °C
- Heating from two sides
- Ceramic heating plates with integral heating element which is safeguarded against fumes and splashing, and easy to replace
- Air exchange of more than 6 times per minute
- Good temperature uniformity due to preheating of incoming air
- Insulation made of non-classified fiber material
- Housing made of sheets of textured stainless steel
- Dual shell housing for low external temperatures and stability
- Optional flap door (L) which can be used as work platform or lift door (LT) with hot surface facing away from the operator
- Solid state relays provide for lownoise operation
- Defined application within the constraints of the operating instructions
- Controls description see page 60





LVT 9/11



LV 15/11

**Additional equipment**

- Over-temperature limiter with adjustable cutout temperature for thermal protection class 2 in accordance with EN 60519-2 as temperature limiter to protect the furnace and load
- Please see page 12 for more accessories
- Process control and documentation with Controltherm MV software package see page 63



Over-temperature limiter

Model	Tmax	Inner dimensions in mm			Volume	Outer dimensions in mm			Connected	Electrical	Weight	Minutes
Flap door	°C	w	d	h	in l	W	D	H <sup>1</sup>	load kW	connection*	in kg	to Tmax <sup>2</sup>
LV 3/11	1100	160	140	100	3	380	370	750	1.2	1-phase	20	120
LV 5/11	1100	200	170	130	5	440	470	850	2.4	1-phase	35	120
LV 9/11	1100	230	240	170	9	480	550	900	3.0	1-phase	45	120
LV 15/11	1100	230	340	170	15	480	650	900	3.5	1-phase	55	120

Model	Tmax	Inner dimensions in mm			Volume	Outer dimensions in mm			Connected	Electrical	Weight	Minutes
Lift door	°C	w	d	h	in l	W	D	H <sup>1</sup>	load kW	connection*	in kg	to Tmax <sup>2</sup>
LVT 3/11	1100	160	140	100	3	380	370	750	1.2	1-phase	20	120
LVT 5/11	1100	200	170	130	5	440	470	850	2.4	1-phase	35	120
LVT 9/11	1100	230	240	170	9	480	550	900	3.0	1-phase	45	120
LVT15/11	1100	230	340	170	15	480	650	900	3.5	1-phase	55	120

<sup>1</sup>Including exhaust tube (Ø 80 mm)

\*Please see page 60 for more information about supply voltage

<sup>2</sup>If connected at 230 V 1/N/PE resp. 400 V 3/N/PE

# Muffle Furnaces with Embedded Heating Elements in the Ceramic Muffle



Gas supply system for non-flammable protective or reactive gas with shutoff valve and flow meter with regulator valve, piped and ready to connect



Muffle heated from four sides



Over-temperature limiter

## L, LT 9/11/SKM

We particularly recommend the muffle furnace L 9/11/SKM if your application involves aggressive substances. The furnace has a ceramic muffle with embedded heating from four sides. The muffle furnace thus combines a very good temperature uniformity with excellent protection of the heating elements from aggressive atmospheres. Another aspect is the smooth, nearly particle free muffle (furnace door made of fiber insulation), an important quality feature for some ashing processes.

- Tmax 1100 °C
- Muffle heated from four sides
- Furnace chamber with embedded ceramic muffle, high resistance to aggressive gasses and vapours
- Housing made of sheets of textured stainless steel
- Optional flap door (L) which can be used as work platform or lift door (LT) with hot surface facing away from the operator
- Adjustable working air inlet in the door
- Exhaust air outlet in rear wall of furnace
- Solid state relays provide for lownoise operation
- Defined application within the constraints of the operating instructions
- Controls description see page 60

### Additional equipment

- Chimney, chimney with fan or catalytic converter
- Over-temperature limiter with adjustable cutout temperature for thermal protection class 2 in accordance with EN 60519-2 as temperature limiter to protect the furnace and load
- Protective gas connection to purge with non-flammable protective or reaction gases
- Manual or automation gas supply system
- Please see page 12 for more accessories

Model	Tmax °C	Inner dimensions in mm			Volume in l	Outer dimensions in mm			Connected load kW	Electrical connection*	Weight in kg	Minutes to Tmax <sup>2</sup>
		w	d	h		W	D	H				
L 9/11/SKM	1100	230	240	170	9	480	550	570	3.0	1-phase	50	90
LT 9/11/SKM	1100	230	240	170	9	480	550	570+290 <sup>1</sup>	3.0	1-phase	50	90

<sup>1</sup>Including opened lift door

<sup>2</sup>If connected at 230 V 1/N/PE resp. 400 V 3/N/PE

\*Please see page 60 for more information about supply voltage

## Weighing Furnace incl. Scale and Software for Determination of Combustion Loss

### L 9/11/SW - LT 9/12/SW

This weighing furnace with integrated precision scale and software, was designed especially for combustion loss determination in the laboratory. The determination of combustion loss is necessary, for instance, when analyzing sludges and household garbage, and is also used in a variety of technical processes for the evaluation of results. The difference between the initial total mass and the combustion residue is the combustion loss. During the process, the software included records both the temperature and the weight loss.

- Tmax 1100 °C or 1200 °C
- Heating from two sides
- Ceramic heating plates with integral heating element which is safeguarded against fumes and splashing, and easy to replace
- Insulation made of non-classified fiber material
- Housing made of sheets of textured stainless steel
- Optional flap door (L) which can be used as work platform or lift door (LT) with hot surface facing away from the operator
- Adjustable working air inlet in the door
- Exhaust air outlet in rear wall of furnace
- Solid state relays provide for lownoise operation
- Delivery includes base, ceramic plunger with base plate in the furnace lining, precision scale and software package
- 4 scales available for different maximum weights and scaling ranges
- Software for documentation of the temperature curve and combustion loss using a PC
- Defined application within the constraints of the operating instructions
- Controls description see page 60

### Additional equipment

- Chimney, chimney with fan or catalytic converter
- Over-temperature limiter with adjustable cutout temperature for thermal protection class 2 in accordance with EN 60519-2 as temperature limiter to protect the furnace and load
- Please see page 12 for more accessories



L 9/11/SW



4 scales available for different maximum weights and scaling areas



Over-temperature limiter

Model flap door	Tmax °C	Inner dimensions in mm			Volume in l	Outer dimensions in mm			Connected load kW	Electrical connection*	Weight in kg	Minutes to Tmax <sup>2</sup>
		w	d	h		W	D	H				
L 9/11/SW	1100	230	240	170	9	480	550	800	3.0	1-phase	55	75
L 9/12/SW	1200	230	240	170	9	480	550	800	3.0	1-phase	55	90

Model Lift door	Tmax °C	Inner dimensions in mm			Volume in l	Outer dimensions in mm			Connected load kW	Electrical connection*	Weight in kg	Minutes to Tmax <sup>2</sup>
		w	d	h		W	D	H <sup>1</sup>				
LT 9/11/SW	1100	230	240	170	9	480	550	800+290	3.0	1-phase	55	75
LT 9/12/SW	1200	230	240	170	9	480	550	800+290	3.0	1-phase	55	90

<sup>1</sup>Including opened lift door

\*Please see page 60 for more information about supply voltage

<sup>2</sup>If connected at 230 V 1/N/PE resp. 400 V 3/N/PE

Scale type	Readability in g	Weight range in g	Weight of plunger in g	Calibration value in g	Minimum load in g
EW-2200	0,01	2200 incl. plunger	850	0,1	0,5
EW-4200	0,01	4200 incl. plunger	850	0,1	0,5
EW-6200	0,01	6200 incl. plunger	850	-	1,0
EW-12000	0,10	12000 incl. plunger	850	1,0	5,0

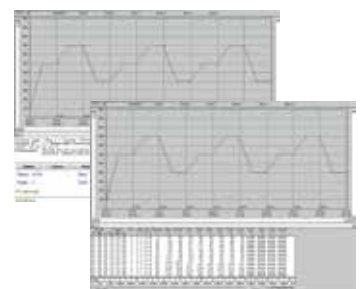

Software for documentation of the temperature curve and combustion loss using a PC

## Exhaust Systems/Accessories



Article No.:  
631000140

**Chimney** for connection to an exhaust pipe.



Article No.:  
631000812

**Chimney with fan**, to remove exhaust gas from the furnace better. The B 400 - P 480 controllers can be used to activate the fan automatically (not for models L(T) 15.., L 1/12, LE 1/11, LE 2/11).\*

\* Note: If other controller types are used an adapter cable for connection to mains supply has to be ordered separately. The device will be activated by plugging in the socket.



Article No.:  
631000166

**Catalytic converter with fan** for removal of organic components from the exhaust air. Organic components are catalytically oxidized at about 600 °C, broken into carbon dioxide and water vapour. Irritating odors are thus largely eliminated. The B 400 - P 480 controllers can be used to switch the catalytic converter automatically (not for models L(T) 15.., L 1/12, LE 1/11, LE 2/11).\*



**Exhaust torch** to burn exhaust gases which are generated during the process. The torch is gas-fired and will be operated with propane gas. If a catalytic afterburner cannot be used for the process this torch is recommended.



Article No.:  
699000279 (saggars)  
699000985 (lid)

**Square saggars for furnaces HTC and LHT, Tmax 1600 °C**

The load is placed in ceramic saggars for optimal utilization of the furnace space. Up to three saggars can be stacked on top of each other in the furnace. Each saggars has cut-outs for better ventilation. The top saggars should be closed with a lid made of ceramics also.



Article No.:  
699001054 (sintering dish)  
699001055 (spacer ring)

**Round saggars (Ø 115 mm) for furnaces LHT/LB, Tmax 1650 °C**

These saggars are perfectly suited for furnaces LHT/LB. The load is placed in the saggars. Up to three saggars can be stacked on top of each other in order to use the overall furnace chamber.

Select between different **bottom plates** and **collecting pans** for protection of the furnace and easy loading (for models L, LT, LE, LV and LVT on pages 4 - 11).



**Ceramic ribbed plate, Tmax 1200 °C**



**Ceramic collecting pan, Tmax 1300 °C**

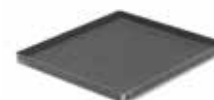

**Steel collecting pan, Tmax 1100 °C**

For models	Ceramic ribbed plate		Ceramic collecting pan		Steel collecting pan (Material 1.4828)	
	Articel No.	Dimensions in mm	Articel No.	Dimensions in mm	Articel No.	Dimensions in mm
L 1, LE 1	691601835	110 x 90 x 12.7	-	-	691404623	85 x 100 x 20
LE 2	691601097	170 x 110 x 12.7	691601099	100 x 160 x 10	691402096	110 x 170 x 20
L 3, LT 3, LV 3, LVT 3	691600507	150 x 140 x 12.7	691600510	150 x 140 x 20	691400145	150 x 140 x 20
LE 6, L 5, LT 5, LV 5, LVT 5	691600508	190 x 170 x 12.7	691600511	190 x 170 x 20	691400146	190 x 170 x 20
L 9, LT 9, LV 9, LVT 9, N 7	691600509	240 x 220 x 12.7	691600512	240 x 220 x 20	691400147	240 x 220 x 20
LE 14	691601098	210 x 290 x 12.7	-	-	691402097	210 x 290 x 20
L 15, LT 15, LV 15, LVT 15, N 11	691600506	340 x 220 x 12.7	-	-	691400149	230 x 330 x 20
L 24, LT 24	691600874	340 x 270 x 12.7	-	-	691400626	270 x 340 x 20
L 40, LT 40	691600875	490 x 310 x 12.7	-	-	691400627	310 x 490 x 20

Heat-resistant **gloves** for protection of the operator when loading or removing hot materials, resistant to 650 °C or 700 °C.



Article No.:  
493000004

**Gloves, Tmax 650 °C.**



Article No.:  
491041101

**Gloves, Tmax 700 °C.**



Article No.:  
493000002 (300 mm)  
493000003 (500 mm)

**Various tongs** for easy loading and unloading of the furnace.

## Assay Furnaces



N 25/13 CUP



N 8/13 CUP with optional base frame on castors

These furnaces are especially used for the assay of precious metals and ashing processes where the insulation and heating must be protected from emerging gasses and vapours. The furnace chamber forms a ceramic muffle which can easily be replaced. The assay furnace is equipped with an integrated exhaust hood above the furnace door for connection to an exhaust system.

- Muffle heated from four sides (three sides for model N 25/13 CUP)
- Heating elements and insulation protected by muffle
- Simple replacement of muffle
- Warm furnace can be opened
- Tool holder on furnace
- Stainless steel exhaust chimney above the door opening for connection of an exhaust system
- Dual shell housing with fan cooling to reduce exterior temperatures
- Defined application within the constraints of the operating instructions
- Controls description see page 60

### Additional equipment

- Base frame on castors (not for model N 4/13 CUP)

### Pit-type furnace with rolling lid

- For bigger charges we offer pit-type furnaces as assay furnaces



Laboratory assay furnace N 4/13 CUP



Pit-type furnace S 73/HS with rolling lid

Model	Tmax °C	Inner dimensions in mm			Volume in l	Outer dimensions in mm			Connected load kW	Electrical connection*	Weight in kg
		w	d	h		W	D	H			
N 4/13 CUP	1280	185	250	80	3.7	750	675	520 <sup>1</sup>	3	1-phase	65
N 8/13 CUP	1300	260	340	95	8.0	900	1335	2100	22	3-phase	510
N 25/13 CUP	1300	250	500	250	25.0	1050	1200	1520 <sup>2</sup>	15	3-phase	280

<sup>1</sup>Plus 150 mm for exhaust hood

<sup>2</sup>Plus 200 mm for exhaust hood

\*Please see page 60 for more information about supply voltage



## Annealing, Hardening and Brazing Furnaces



N 7/H as table-top model



N 61/H

### N 7/H - N 87/H

To withstand harsh use in the laboratory, e.g. when heat-treating metals, robust insulation with light refractory bricks is necessary. The N 7/H - N 87/H models are a perfect fit to solve this problem.

The furnaces can be extended with a variety of accessories, like annealing boxes for operation under protective gas, roller guides, or a cooling station with a quench tank. Even high-performance applications like the annealing of titanium in medical applications can be implemented without the use of expensive and complicated annealing systems.



Working with protective gas boxes for a protective gas atmosphere using a charging cart

- Tmax 1280 °C
- Three-sided heating from both sides and the bottom
- Heating elements on support tubes ensure free heat radiation and a long service life
- Bottom heating protected by heat-resistant SiC plate
- Multi-layer insulation with high-quality lightweight refractory bricks in the furnace chamber
- Exhaust opening in the side of the furnace, or on back wall of furnace in the N 31/H models and higher
- Models N 7/H - N 17/HR are designed as tabletop models
- Base included with model N 31/H and up
- Parallel swinging door which opens downward, or upward upon request
- Defined application within the constraints of the operating instructions
- Controls description see page 60

Model	Tmax °C	Inner dimensions in mm			Volume in l	Outer dimensions in mm			Connected load kW	Electrical connection*	Weight in kg	Minutes to Tmax <sup>2</sup>
		w	d	h		W	D	H				
N 7/H	1280	250	250	140	9	770	650	570	3.0	1-phase	60	180
N 11/H	1280	250	350	140	11	770	750	570	3.6	1-phase	70	180
N 11/HR	1280	250	350	140	11	770	770	570	5.5	3-phase <sup>1</sup>	70	120
N 17/HR	1280	250	500	140	17	770	900	570	6.4	3-phase <sup>1</sup>	90	120
N 31/H	1280	350	350	250	31	1010	1010	1340	15.0	3-phase	210	105
N 41/H	1280	350	500	250	41	1010	1160	1340	15.0	3-phase	260	120
N 61/H	1280	350	750	250	61	1010	1410	1340	20.0	3-phase	400	120
N 87/H	1280	350	1000	250	87	1010	1660	1340	25.0	3-phase	480	120

<sup>1</sup>Heating only between two phases

<sup>2</sup>If connected at 230 V 1/N/PE resp. 400 V 3/N/PE

\*Please see page 60 for more information about supply voltage

## Accessories for Hardening and Brazing

Our wide selection of annealing, hardening and brazing furnaces can be extended with a variety of accessories for hardening and brazing to suit your application. The accessories shown below represent only a small fraction of the products available. For further details, please see our separate catalogues for heat-treatment furnaces and hardening accessories.

### Annealing Boxes

- Annealing boxes with or without protective gas connectors, up to 1100 °C, also in a tailor-made variant for cold evacuation, for instance for the annealing of small parts and bulk goods



### Annealing Tray with Holder

- Annealing tram with alloy bag and holder with protective gas connection for models N 7/H to N 87/H for annealing and hardening under protective gas and quenching in air



### Hearth Plates

- Hearth plates for up to 1100 °C for protection of the furnace floor for models N 7/H to N 87/H, edged on three sides



### Hardening Tongs

- Hardening tongs in various sizes and forms for use in annealing and hardening



### Heat Treating Foil

- Heat treating foil for wrapping of samples for oxidation-free annealing and hardening of steels up to 1200 °C



### Gloves

- Heat-resistant gloves to 650 °C or 700 °C for protection of operator during loading see page 12

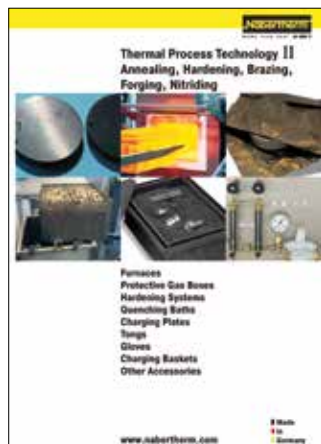

Please ask for our separate catalogues for hardening furnaces and hardening accessories!

## Chamber Furnaces with Brick Insulation or Fiber Insulation



Chamber furnace LH 15/12 with brick insulation



LH 120/12SW with scale to measure weight reduction during annealing

### LH 15/12 - LF 120/14

The chamber furnaces LH 15/12 - LF 120/14 have been trusted for many years as professional chamber furnaces for the laboratory. These furnaces are available with either a robust insulation of light refractory bricks (LH models) or with a combination insulation of refractory bricks in the corners and low heat storage, quickly cooling fiber material (LF models). With a wide variety of optional equipment, these chamber furnaces can be optimally adapted to your processes.

- Tmax 1200 °C, 1300 °C, or 1400 °C
- Five-sided heating for very good temperature uniformity
- Heating elements on support tubes ensure free heat radiation and a long service life
- Protection of bottom heating and flat stacking surface provided by embedded SiC plate in the floor
- LH models: multi-layered, fiber-free insulation of light refractory bricks and special backup insulation



Cooling fan in combination with motor-driven exhaust air flap to reduce cooling time

- LF models: high-quality non-classified fiber insulation with corner bricks for shorter heating and cooling times
- Door with brick-on-brick seal, hand fitted
- Short heating times due to high installed power
- Side vent with bypass connection for exhaust pipe
- Self-supporting arch for high stability and greatest possible protection against dust
- Quick lock on door
- Freely adjustable air slide intake in furnace floor
- Base included
- Defined application within the constraints of the operating instructions
- Controls description see page 60

#### Additional equipment

- Parallel swinging door, pivots away from operator, for opening when hot
- Lift door with electro-mechanic linear drive
- Separate wall-mounting or floor standing cabinet for switchgear
- Motor-driven exhaust air flap



LH 120/12S with inner process box made of quartz glass



Chamber furnace LH 216/12SW with scale to measure weight reduction during annealing

- Cooling fan for shorter cycle times
- Protective gas connection to purge with non-flammable protective or reaction gases
- Inner process box made of quartz glass for very clean atmosphere, quartz glass covered door with lid function
- Manual or automatic gas supply system
- Scale to measure weight reduction during annealing



LH 60/12 with manual lift door and gas supply box for non-flammable protective or reactive gases

Model	Tmax °C	Inner dimensions in mm			Volume in l	Outer dimensions in mm			Connected load kW	Electrical connection*	Weight in kg
		w	d	h		W	D	H			
LH 15/12	1200	250	250	250	15	570	790	1170	5.0	3-phase <sup>1</sup>	150
LH 30/12	1200	320	320	320	30	640	860	1240	7.0	3-phase <sup>1</sup>	170
LH 60/12	1200	400	400	400	60	720	1010	1320	8.0	3-phase	260
LH 120/12	1200	500	500	500	120	820	1110	1420	12.0	3-phase	340
LH 216/12	1200	600	600	600	216	900	1210	1530	20.0	3-phase	400
LH 15/13	1300	250	250	250	15	570	790	1170	7.0	3-phase <sup>1</sup>	150
LH 30/13	1300	320	320	320	30	640	860	1240	8.0	3-phase <sup>1</sup>	170
LH 60/13	1300	400	400	400	60	720	1010	1320	11.0	3-phase	260
LH 120/13	1300	500	500	500	120	820	1110	1420	15.0	3-phase	340
LH 216/13	1300	600	600	600	216	900	1210	1530	22.0	3-phase	400
LH 15/14	1400	250	250	250	15	570	790	1170	8.0	3-phase <sup>1</sup>	150
LH 30/14	1400	320	320	320	30	640	860	1240	10.0	3-phase <sup>1</sup>	170
LH 60/14	1400	400	400	400	60	720	1010	1320	12.0	3-phase	260
LH 120/14	1400	500	500	500	120	820	1110	1420	18.0	3-phase	340
LH 216/14	1400	600	600	600	216	900	1210	1530	26.0	3-phase	400
LF 15/13	1300	250	250	250	15	570	790	1170	7.0	3-phase <sup>1</sup>	130
LF 30/13	1300	320	320	320	30	640	860	1240	8.0	3-phase <sup>1</sup>	150
LF 60/13	1300	400	400	400	60	720	1010	1320	11.0	3-phase	230
LF 120/13	1300	500	500	500	120	820	1110	1420	15.0	3-phase	300
LF 15/14	1400	250	250	250	15	570	790	1170	8.0	3-phase <sup>1</sup>	130
LF 30/14	1400	320	320	320	30	640	860	1240	10.0	3-phase <sup>1</sup>	150
LF 60/14	1400	400	400	400	60	720	1010	1320	12.0	3-phase	230
LF 120/14	1400	500	500	500	120	820	1110	1420	18.0	3-phase	300

<sup>1</sup>Heating only between two phases

\*Please see page 60 for more information about supply voltage



Parallel swinging door for opening when hot



Gas supply system for non-flammable protective or reaction gases



# High-Temperature Furnaces with SiC Rod Heating up to 1600 °C



HTC 08/15



HTCT 01/16



Furnace chamber with high-quality fiber materials and SiC heating rods on both sides of the furnace

## HTCT 03/14 - HTCT 08/16

These powerful laboratory muffle furnaces are available for temperatures up to 1400 °C, 1500 °C, 1550 °C or 1600 °C. The durability of the SiC rods in periodic use, in combination with their high heating speed, make these high-temperature furnaces to all-rounders in the laboratory. Heating times of 40 minutes to 1400 °C can be achieved, depending on the furnace model and the conditions of use.

- Tmax 1400 °C, 1500 °C, 1550 °C or 1600 °C
- Working temperature 1500 °C (for high-temperature furnaces HTC ../16), increased wear and tear must be expected in case of working at higher temperatures
- High-quality non-classified fiber material, selected for the working temperature
- Housing made of sheets of textured stainless steel
- Dual shell housing for low external temperatures and high stability
- Optional flap door (HTC) which can be used as work platform or lift door (HTCT) with hot surface facing away from the operator (HTCT 01/16 only with lift door)
- Switching system with solid-state-relays, power tuned to the SiC rods
- Easy replacement of heating rods
- Defined application within the constraints of the operating instructions
- Controls description see page 60

## Additional equipment

- Over-temperature limiter with adjustable cutout temperature for thermal protection class 2 in accordance with EN 60519-2 as temperature limiter to protect the furnace and load
- Square saggars for charging of up to three layers see page 12
- Lid for top saggars
- Manual or automatic gas supply system
- Adjustable air intake opening in the furnace door, exhaust air opening in the roof



Saggars with top lid



Over-temperature limiter

Model	Tmax °C	Inner dimensions in mm			Volume in l	Outer dimensions in mm			Connected load kW	Electrical connection*	Weight in kg	Minutes to Tmax <sup>3</sup>
		w	d	h		W	D	H <sup>2</sup>				
HTC, HTCT 03/14	1400	120	210	120	3.0	400	535	530	9.0	3-phase <sup>1</sup>	30	40
HTC, HTCT 08/14	1400	170	290	170	8.0	450	620	570	13.0	3-phase	40	40
HTC, HTCT 03/15	1500	120	210	120	3.0	400	535	530	9.0	3-phase <sup>1</sup>	30	50
HTC, HTCT 08/15	1500	170	290	170	8.0	450	620	570	13.0	3-phase	40	50
HTCT 01/16	1550	110	120	120	1.5	340	440	460	4.5	1-phase	18	40
HTC, HTCT 03/16	1600	120	210	120	3.0	400	535	530	9.0	3-phase <sup>1</sup>	30	60
HTC, HTCT 08/16	1600	170	290	170	8.0	450	620	570	13.0	3-phase	40	60

<sup>1</sup>Heating only between two phases

<sup>2</sup>Plus maximum 270 mm for models HTCT when open

\*Please see page 60 for more information about supply voltage

<sup>3</sup>If connected at 230 V 1/N/PE resp. 400 V 3/N/PE



## High-Temperature Furnaces with MoSi<sub>2</sub> Heating Elements up to 1800 °C



LHT 01/17 D

### LHT 01/17 D, LHT 03/17 D, LHT 02/16 - LHT 08/18

Designed as tabletop models, these compact high-temperature furnaces have a variety of advantages. The first-class workmanship using high-quality materials, combined with ease of operation, make these furnaces all-rounders in research and the laboratory. These high-temperature furnaces are also perfectly suited for the sintering of technical ceramics, such as zirconium oxide dental bridges.

- Tmax 1600 °C, 1750 °C, or 1800 °C
- High-quality molybdenum disilicide heating elements
- Furnace chamber lined with first-class, durable fiber material
- Housing made of sheets of textured stainless steel
- Dual shell housing with additional fan cooling for low surface temperature
- Compact design with lift door, opening upwards
- Adjustable air inlet
- Exhaust air opening in the roof
- Type B thermocouple
- Switching system with phase-angle firing thyristors (SCRs)
- Defined application within the constraints of the operating instructions
- Controls description see page 60

### Additional equipment

- Over-temperature limiter with adjustable cutout temperature for thermal protection class 2 in accordance with EN 60519-2 as temperature limiter to protect the furnace and load
- Square saggars for charging of up to three layers see page 12
- Process control and documentation with Controltherm MV software package see page 63
- Protective gas connection to purge with non-flammable protective or reaction gases
- Manual or automatic gas supply system



LHT 03/17 D



Saggars with top lid

Model	Tmax °C	Inner dimensions in mm			Volume in l	Outer dimensions in mm			Connected load kW	Electrical connection*	Weight in kg	Minutes to Tmax <sup>2</sup>
		w	d	h		W	D	H <sup>3</sup>				
LHT 02/16	1600	90	150	150	2	470	700	750+350	3.0	1-phase	75	30
LHT 04/16	1600	150	150	150	4	470	700	750+350	5.2	3-phase <sup>1</sup>	85	25
LHT 08/16	1600	150	300	150	8	470	850	750+350	8.0	3-phase <sup>1</sup>	100	25
LHT 01/17 D	1650	110	120	120	1	382	425	525+195	3.6 <sup>2</sup>	1-phase	28	10
LHT 03/17 D	1650	135	155	200	2	470	620	770+260	3.0	1-phase	75	60
LHT 02/17	1750	90	150	150	2	470	700	750+350	3.0	1-phase	75	60
LHT 04/17	1750	150	150	150	4	470	700	750+350	5.2	3-phase <sup>1</sup>	85	40
LHT 08/17	1750	150	300	150	8	470	850	750+350	8.0	3-phase <sup>1</sup>	100	40
LHT 02/18	1800	90	150	150	2	470	700	750+350	3.6	1-phase	75	75
LHT 04/18	1800	150	150	150	4	470	700	750+350	5.2	3-phase <sup>1</sup>	85	60
LHT 08/18	1800	150	300	150	8	470	850	750+350	9.0	3-phase <sup>1</sup>	100	60

<sup>1</sup>Heating only between two phases

<sup>2</sup>If connected at 230 V 1/N/PE resp. 400 V 3/N/PE

\*Please see page 60 for more information about supply voltage

<sup>3</sup>Including opened lift door



Over-temperature limiter

## High-Temperature Furnaces Lift-Bottom up to 1700 °C



LHT 02/17 LB with a set of saggars



LHT 16/17 LB



Electrically driven lift-bottom

### LHT/LB

The electrically driven lift-bottom considerably allows for proper charging of the high-temperature furnaces LHT/LB. The heating all around the cylindrical furnace chamber provides for an optimal temperature uniformity. For model LHT 02/17 LB the charge can be placed in charge saggars made of technical ceramics. Up to three charge saggars can be stacked on top of each other resulting in a high productivity. Due to its volume model LHT 16/17 LB can also be used for applications in production.

- Tmax 1700 °C
- High-quality molybdenum disilicide heating elements
- Furnace chamber lined with first-class, durable fiber materials
- Outstanding temperature uniformity due to all-round furnace chamber heating
- Furnace chamber with a volume of 2 or 16 liters, table with large floor space
- Spacers to lift-up the saggars already installed in the table
- Precise, electric spindle drive with push button operation
- Housing made of sheets of textured stainless steel
- Exhaust air vent in the roof
- Type S thermocouple
- Switchgear with thyristor
- Defined application within the constraints of the operating instructions
- Controls description see page 60



Sagger

**Additional equipment**

- Over-temperature limiter with adjustable cutout temperature for thermal protection class 2 in accordance with EN 60519-2 as temperature limiter to protect the furnace and load
- Sagger for charging of up to three layers see page 12
- Protective gas connection to purge with non-flammable protective or reaction gases
- Manual or automatic gas supply system
- Adjustable air inlet through the floor
- Process control and documentation with Controltherm MV software package see page 63

Model	Tmax °C	Inner dimensions in mm			Volume in l	Outer dimensions in mm			Connected load kW	Electrical connection*	Weight in kg
		Ø		h		W	D	H			
LHT 02/17 LB	1700	Ø 120		130	2	540	610	740	3.3	1-phase	85
LHT 16/17 LB	1700	Ø 260		260	16	650	1250	1980	12.0	3-phase	410

\*Please see page 60 for more information about supply voltage

## High-Temperature Furnaces with Scale for Determination of Combustion Loss and Thermogravimetric Analysis (TGA)



LHT 04/16 SW with scale for measuring weight reduction during annealing and with gas supply system

### LHT 04/16 SW and LHT 04/17 SW

These high-temperature furnaces were specially developed to determine combustion loss during annealing and for thermogravimetric analysis (TGA) in the lab. The complete system consists of the high-temperature furnace for 1600 °C or 1750 °C, a table frame, precision scale with feedthroughs into the furnace and powerful software for recording both the temperature curve and the weight loss over time.

- Defined application within the constraints of the operating instructions
- Technical description of the furnaces: see models LHT 04/16 and LHT 04/17 page 19
- Description of the weighing system: see models L 9/... SW page 11

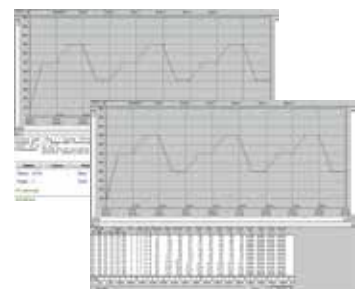

Software for documentation of the temperature curve and combustion loss using a PC

Model	Tmax °C	Inner dimensions in mm			Volume in l	Outer dimensions in mm			Connected load kW	Electrical connection*	Weight in kg	Minutes to Tmax <sup>2</sup>
		w	d	h		W	D	H				
LHT 04/16 SW	1600	150	150	150	4	655	370	890	5.0	3-phase <sup>1</sup>	85	25
LHT 04/17 SW	1750	150	150	150	4	655	370	890	5.0	3-phase <sup>1</sup>	85	40

<sup>1</sup>Heating only between two phases

\*Please see page 60 for more information about supply voltage

<sup>2</sup>If connected at 230 V 1/N/PE resp. 400 V 3/N/PE

## High-Temperature Furnaces with Fiber Insulation up to 1800 °C



HT 16/18 with gas supply system



HT 160/17 with gas supply system



Reinforced floor as protection for bottom insulation HT 16/16



Inner process hood with gas injection through the furnace bottom protects the furnace chamber against contamination and/or prevents chemical interaction between the charge and heating elements

### HT 04/16 - HT 450/18

Due to their solid construction and compact stand-alone design, these high-temperature furnaces are perfect for processes in the laboratory where the highest precision is needed. Outstanding temperature uniformity and practical details set unbeatable quality benchmarks. For configuration for your processes, these furnaces can be extended with extras from our extensive option list.

- Tmax 1600 °C, 1750 °C, or 1800 °C
- Working temperature 1750 °C (for models HT ../18), increased wear and tear must be expected in case of working at higher temperatures
- Furnace sizes from 4 to 450 liters
- High-quality molybdenum disilicide (MoSi<sub>2</sub>) heating elements
- Parallel swivel door, chain-guided, enabling safe opening and closing without damage to the fiber insulation in the collar area, protection of user from radiation from the furnace
- Two-door design for high-temperature furnaces > HT 276/..
- Door labyrinth sealing provides for optimum energy efficiency and temperature uniformity
- Door area armored with stainless steel to avoid burn damages
- Reinforced floor as protection for bottom insulation as standard from models HT 16/16 upwards
- Over-temperature limiter with manual reset for product and furnace protection
- Furnace chamber lined with first-class, durable fiber material
- Special ceiling construction with high durability
- Thermocouple, PtRh-Pt, Type B or Type S
- Vapor vent in the furnace roof
- Defined application within the constraints of the operating instructions
- Controls description see page 60

Additional equipment

- Uncontrolled or controlled cooling system with frequency-controlled cooling fan and motor-driven exhaust air flap
- Furnace in HDB design featuring fresh air preheating, exhaust gas ventilation and an extensive safety package for debinding and sintering in one process, i. e. without transferring the material from the debinding furnace to the sintering furnace.
- Motor-driven exhaust air flap control
- Stainless steel exhaust gas hoods
- Catalytic or thermal afterburners
- Kiln furniture
- Lift door
- Special heating elements for zirconia sintering provide for longer service life with respect to chemical interaction between charge and heating elements
- Protective gas connection to purge with non-flammable protective or reaction gases
- Manual or automatic gas supply system
- Inner process box to improve the gas tightness and to protect the furnace chamber against contamination



HT 276/17 with pneumatically driven and parallel lift door

Model	Tmax °C	Inner dimensions in mm			Volume in l	Outer dimensions in mm			Connected load kW	Electrical connection*	Weight in kg
		w	d	h		W	D	H			
HT 04/16	1600	150	150	150	4	610	470	1400	5.2	3-phase <sup>1</sup>	150
HT 08/16	1600	150	300	150	8	730	640	1400	8.0	3-phase <sup>1</sup>	200
HT 16/16	1600	200	300	260	16	810	700	1500	12.0	3-phase <sup>1</sup>	270
HT 40/16	1600	300	350	350	40	1000	800	1620	12.0	3-phase	380
HT 64/16	1600	400	400	400	64	1130	900	1670	18.0	3-phase	550
HT 128/16	1600	400	800	400	128	1130	1290	1670	26.0	3-phase	750
HT 160/16	1600	500	550	550	160	1245	1040	1900	21.0	3-phase	800
HT 276/16	1600	500	1000	550	276	1140	1470	1900	36.0	3-phase	1100
HT 450/16	1600	500	1150	780	450	1200	1620	2060	64.0	3-phase	1500
HT 04/17	1750	150	150	150	4	610	470	1400	5.2	3-phase <sup>1</sup>	150
HT 08/17	1750	150	300	150	8	730	640	1400	8.0	3-phase <sup>1</sup>	200
HT 16/17	1750	200	300	260	16	810	700	1500	12.0	3-phase <sup>1</sup>	270
HT 40/17	1750	300	350	350	40	1000	800	1620	12.0	3-phase	380
HT 64/17	1750	400	400	400	64	1130	900	1670	18.0	3-phase	550
HT 128/17	1750	400	800	400	128	1300	1290	1670	26.0	3-phase	750
HT 160/17	1750	500	550	550	160	1245	1040	1900	21.0	3-phase	800
HT 276/17	1750	500	1000	550	276	1140	1470	1900	36.0	3-phase	1100
HT 450/17	1750	500	1150	780	450	1200	1620	2060	64.0	3-phase	1500
HT 04/18	1800	150	150	150	4	610	470	1400	5.2	3-phase <sup>1</sup>	150
HT 08/18	1800	150	300	150	8	730	640	1400	9.0	3-phase <sup>1</sup>	200
HT 16/18	1800	200	300	260	16	810	700	1500	12.0	3-phase <sup>1</sup>	270
HT 40/18	1800	300	350	350	40	1000	800	1620	12.0	3-phase	380
HT 64/18	1800	400	400	400	64	1130	900	1670	18.0	3-phase	550
HT 128/18	1800	400	800	400	128	1130	1290	1670	26.0	3-phase	750
HT 160/18	1800	500	550	550	160	1260	1070	1900	21.0	3-phase	800
HT 276/18	1800	500	1000	550	276	1140	1470	1900	36.0	3-phase	1100
HT 450/18	1800	500	1150	780	450	1200	1620	2060	64.0	3-phase	1500



Two-door design for models > HT 276/..

<sup>1</sup>Heating only between two phases

\*Please see page 60 for more information about supply voltage



## High-Temperature Furnaces with SiC Rod Heating up to 1550 °C



HTC 40/16



HTC 16/16



Vertically mounted SiC rods

### HTC 16/16 - HTC 450/16

The high-temperature furnaces HTC 16/16 - HTC 450/16 are heated by vertically hung SiC rods, which makes them especially suitable for sintering processes up to a maximum operating temperature of 1550 °C. For some processes, e.g. for sintering zirconium oxide, the absence of interactivity between the charge and the SiC rods, these models are more suitable than the alternatives heated with molybdenum disilicide elements. The basic construction of these furnaces make them comparable with the already familiar models in the HT product line and they can be upgraded with the same additional equipment.

- Tmax 1550 °C
- Dual shell housing with fan cooling for low shell temperatures
- Heating from both sides via vertically mounted SiC rods
- High-quality fiber insulation backed by special insulation
- Side insulation constructed with tongue and groove blocks provides for low heat loss to the outside
- Long-life roof insulation with special suspension
- Chain-guided parallel swivel door for defined opening and closing of the door without destroying the insulation
- Two-door design for models > HT 276/..
- Labyrinth sealing ensures the least possible temperature loss in the door area
- Specially reinforced furnace floor for accommodating high charge weights for model HTC 16 and above
- Exhaust air opening in the furnace roof
- Heating elements switched via SCR's
- Over-temperature limiter with adjustable cutout temperature for thermal protection class 2 in accordance with EN 60519-2 as temperature limiter to protect the furnace and load
- Defined application within the constraints of the operating instructions
- Controls description see page 60



Exhaust air flap and charge thermocouple including a stand as additional equipment

For additional equipment see models HT 04/16 - HT 450/18

Model	Tmax °C	Inner dimensions in mm			Volume in l	Outer dimensions in mm			Connected load kW	Electrical connection*	Weight in kg
		w	d	h		W	D	H			
HTC 16/16	1550	200	300	260	16	810	700	1500	12,0	3-phase <sup>1</sup>	270
HTC 40/16	1550	300	350	350	40	1000	800	1620	12,0	3-phase	380
HTC 64/16	1550	400	400	400	64	1130	900	1670	18,0	3-phase	550
HTC 128/16	1550	400	800	400	128	1130	1290	1670	26,0	3-phase	750
HTC 160/16	1550	500	550	550	160	1245	1040	1900	21,0	3-phase	800
HTC 276/16	1550	500	1000	550	276	1140	1470	1900	36,0	3-phase	1100
HTC 450/16	1550	500	1150	780	450	1200	1620	2060	64,0	3-phase	1500

<sup>1</sup>Heating only between two phases

\*Please see page 60 for more information about supply voltage

## High-Temperature Furnaces with Refractory Brick Insulation up to 1700 °C



HFL 160/17



HFL 16/17

### HFL 16/16 - HFL 160/17

The high-temperature furnaces HFL 16/16 HFL 160/17 are characterized by their lining with robust light refractory bricks. This version is recommended for processes producing aggressive gases or acids, such as under glass melting.

- Tmax 1600 °C or 1700 °C
- High-quality molybdenum disilicide (MoSi<sub>2</sub>) heating elements
- Insulation with light refractory bricks and special backup insulation
- Type B thermocouple
- Furnace sizes of 16 to 160 liters
- For the release of vapours, a 30 mm large exhaust hole is integrated into the roof of the furnace
- Over-temperature limiter with manual reset for protection of material
- Defined application within the constraints of the operating instructions
- Controls description see page 60

#### Additional equipment

- Exhaust air flap, manually or motor-driven for improved venting of the furnace chamber
- Fan for better ventilation of combustion chamber and for fast cooling of the furnace
- Protective gas connection to purge with non-flammable protective or reaction gases
- Manual or automatic gas supply system



Protective screen in front of heating elements for protection against mechanical damage

Model	Tmax °C	Inner dimensions in mm			Volume in l	Outer dimensions in mm			Connected load kW	Electrical connection*	Weight in kg
		w	d	h		W	D	H			
HFL 16/16	1600	200	300	260	16	770	830	1550	12	3-phase <sup>1</sup>	500
HFL 40/16	1600	300	350	350	40	880	880	1710	12	3-phase	660
HFL 64/16	1600	400	400	400	64	980	930	1830	18	3-phase	880
HFL 160/16	1600	500	550	550	160	1090	1080	2030	21	3-phase	1140
HFL 16/17	1700	200	300	260	16	770	830	1550	12	3-phase <sup>1</sup>	530
HFL 40/17	1700	300	350	350	40	880	880	1710	12	3-phase	690
HFL 64/17	1700	400	400	400	64	980	930	1830	18	3-phase	920
HFL 160/17	1700	500	550	550	160	1090	1080	2030	21	3-phase	1190

<sup>1</sup>Heating only between two phases

\*Please see page 60 for more information about supply voltage



Gas supply system for non-flammable protective or reaction gases

## Ovens, also with Safety Technology According to EN 1539



TR 60 with adjustable fan speed



TR 240



Electrical rotating device as additional equipment



Extricable metal grids to load the oven in different layers

### TR 60 - TR 1050

With their maximum working temperature of up to 300 °C and forced air circulation, the ovens achieve a perfect temperature uniformity which is much better than in ovens of most competitors. They can be used for various applications such as e.g. drying, sterilizing or warm storing. Ample warehousing of standard models provides for short delivery times.

- Tmax 300 °C
- Working temperature range: + 5 °C above room temperature up to 300 °C
- Ovens TR 60 - TR 240 designed as tabletop models
- Ovens TR 450 and TR 1050 designed as floor standing models
- Horizontal, forced air circulation results in temperature uniformity better than +/- 5 °C see page 59
- Stainless steel chamber, alloy 304 (AISI)/(DIN material no. 1.4301), rust-resistant and easy to clean
- Large handle to open and close the door
- Charging in multiple layers possible using removeable grids (number of removeable grids included, see table to the right)
- Large, wide-opening swing door, hinged on the right with quick release for models TR 60 - TR 450
- Double swing door with quick release for TR 1050
- TR 1050 equipped transport rollers
- Infinitely adjustable exhaust at the rear wall with operation from the front
- PID microprocessor control with self-diagnosis system
- Solid state relays provide for lownoise operation
- Defined application within the constraints of the operating instructions
- Controls description see page 60



TR 450



TR 1050 with double door

**Additional equipment**

- Over-temperature limiter with adjustable cutout temperature for thermal protection class 2 in accordance with EN 60519-2 as temperature limiter to protect the oven and load
- Infinitely adjustable fan speed of the air circulation fan
- Window for charge observing
- Further removeable grids with rails
- Side inlet
- Stainless steel collecting pan to protect the furnace chamber
- Safety technology according to EN 1539 for charges containing liquid solvents (TRS) up to model TRS 240, achievable temperature uniformity +/- 8 °C see page 59
- Transport costors for model TR 450
- Various modifications available for individual needs
- Upgrading available to meet the quality requirements of AMS 2750 E or FDA
- Process control and documentation with Controltherm MV software package see page 63



TR 60 with observation window

Model	Tmax °C	Inner dimensions in mm			Volume in l	Outer dimensions in mm			Connected load kW <sup>2</sup>	Electrical connection*	Weight in kg	Grids included	Grids max.	Max. total load <sup>1</sup>
		w	d	h		W	D	H						
TR 60	300	450	380	350	60	700	650	690	3.1	1-phase	90	1	4	120
TRS 60	260	450	360	350	57	700	680	690	6.3	3-phase	92	1	4	120
TR 120	300	650	380	500	120	900	650	840	3.1	1-phase	120	2	7	150
TRS 120	260	650	360	500	117	900	680	840	6.3	3-phase	122	2	7	150
TR 240	300	750	550	600	240	1000	820	940	3.1	1-phase	165	2	8	150
TRS 240	260	750	530	600	235	1000	850	940	6.3	3-phase	167	2	8	150
TR 450	300	750	550	1100	450	1000	820	1440	6.3	3-phase	235	3	15	180
TR 1050	300	1200	630	1400	1050	1470	955	1920	9.3	3-phase	450	4	14	250

<sup>1</sup>Max load per layer 30 kg

\*Please see page 60 for more information about supply voltage

<sup>2</sup>If EN 1539 is ordered connected load will increase

# High-Temperature Ovens, Air Circulation Furnaces

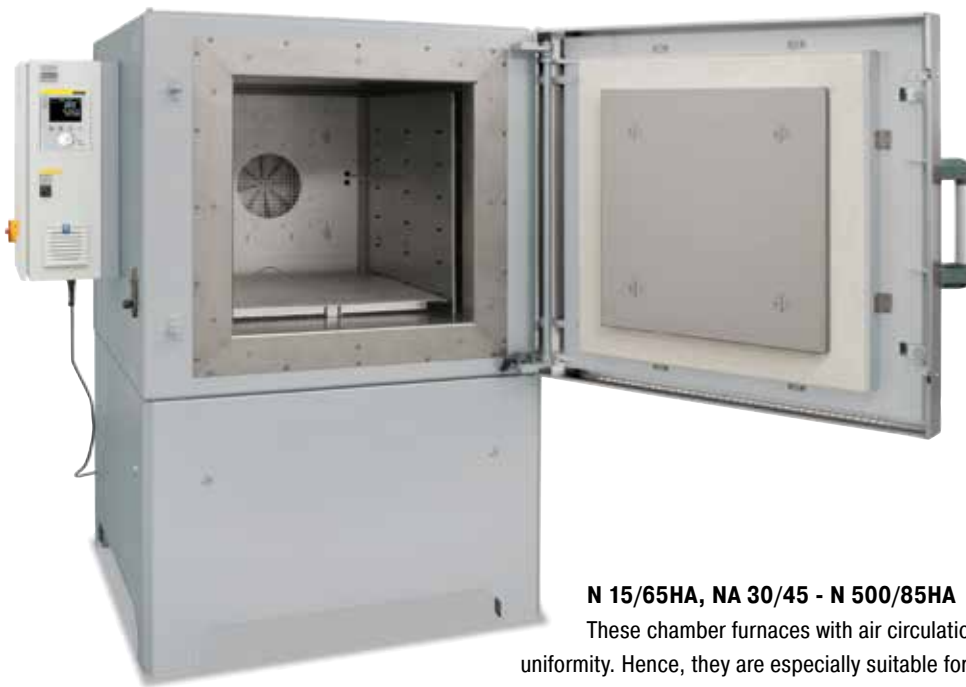

NA 250/45



NA 120/45

## N 15/65HA, NA 30/45 - N 500/85HA

These chamber furnaces with air circulation are characterized by their extremely high temperature uniformity. Hence, they are especially suitable for processes such as cooling, crystallizing, preheating, curing, but also for numerous processes in tool making. Due to the modular concept, the air circulation furnaces can be adjusted to the process requirements by adding suitable equipment.



N 15/65HA as table-top model

- Tmax 450 °C, 650 °C, or 850 °C
- Horizontal air circulation
- Swing door hinged on the right
- Temperature uniformity up to +/- 5 °C according to DIN 17052-1 (model N 15/65 HA up to +/- 7 °C) see page 59
- Optimum air flow and temperature uniformity through high circulation rates
- One shelf and rails for two additional shelves included (N 15/65 HA without removable tray)
- Stainless steel air-baffles in the furnace for optimum air circulation
- Base frame included in the delivery, N 15/65 HA designed as table-top model
- Air inlet and exhaust air flaps as additional equipment for using as drying oven
- Defined application within the constraints of the operating instructions
- Controls description see page 60

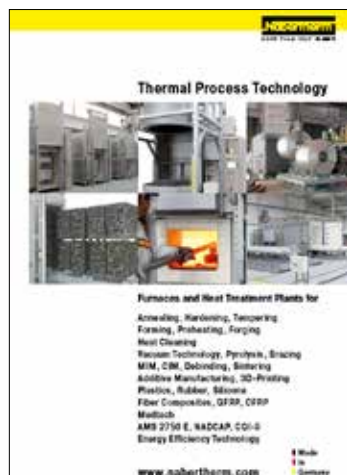

For additional information about air circulation chamber furnaces please ask for our separate catalog!

Model	Tmax °C	Inner dimensions in mm			Volume in l	Outer dimensions in mm			Connected load kW	Electrical connection*	Weight in kg
		w	d	h		W	D	H			
NA 30/45	450	290	420	260	30	1040	1290	1385	3.6	1-phase	195
NA 60/45	450	350	500	350	60	1100	1370	1475	6.6	3-phase	240
NA 120/45	450	450	600	450	120	1200	1470	1575	9.8	3-phase	310
NA 250/45	450	600	750	600	250	1350	1650	1725	12.8	3-phase	610
NA 500/45	450	750	1000	750	500	1500	1850	1800	18.8	3-phase	1030
N 15/65 HA <sup>1</sup>	650	295	340	170	15	470	845	460	2.7	1-phase	55
N 30/65 HA	650	290	420	260	30	607 + 255	1175	1315	6.0	3-phase <sup>2</sup>	195
N 60/65 HA	650	350	500	350	60	667 + 255	1250	1400	9.6	3-phase	240
N 120/65 HA	650	450	600	450	120	767 + 255	1350	1500	13.6	3-phase	310
N 250/65 HA	650	600	750	600	250	1002 + 255	1636	1860	21.0	3-phase	610
N 500/65 HA	650	750	1000	750	500	1152 + 255	1886	2010	31.0	3-phase	1030
N 30/85 HA	850	290	420	260	30	607 + 255	1175	1315	6.0	3-phase <sup>2</sup>	195
N 60/85 HA	850	350	500	350	60	667 + 255	1250	1400	9.6	3-phase	240
N 120/85 HA	850	450	600	450	120	767 + 255	1350	1500	13.6	3-phase	310
N 250/85 HA	850	600	750	600	250	1002 + 255	1636	1860	21.0	3-phase	610
N 500/85 HA	850	750	1000	750	500	1152 + 255	1886	2010	31.0	3-phase	1030

<sup>1</sup>Table-top model

<sup>2</sup>Heating only between two phases

\*Please see page 60 for more information about supply voltage



## Clean Room Solutions

Clean room applications impose particularly high requirements to the design of the chosen furnace. If the complete furnace is operated in a clean room an essential contamination of the clean room atmosphere must be avoided. Especially, the particle contamination must be reduced to a minimum.

The specific application determines the choice of the required furnace technology. In many cases air circulation furnaces are required to achieve the necessary temperature uniformity at lower temperatures. For higher temperatures, Nabertherm has also delivered many furnaces with radiant heating.

### Furnace Installation in the Clean Room

If the complete furnace is supposed to be positioned in the clean room, then it is important that both the furnace chamber and the furnace housing as well as the controls provide for good protection against contamination. Surfaces must be easy to clean. The furnace chamber is tightly sealed to the insulation behind it. If necessary, additional equipment such as filters for the fresh air supply or the air circulation in the furnace can be used to improve the cleanliness class. It is recommended to install the switchgear and the furnace controls outside the clean room.

### Furnace Installation in the Grey Room, Furnace Charging from the Clean Room

Optimal results with respect to cleanness will be achieved by placing the furnace in the grey room with charging from the clean room. This significantly reduces the amount of costly space needed in the clean room to a minimum. The front and the furnace interior in the clean room are designed for easy cleaning. With this configuration even the highest clean room classes can be achieved.

### Sluice Furnace between Grey Room and Clean Room

Logistics between clean room and grey room can often be easily sorted out. Lock furnaces with one door in the grey room and the other door in the clean room are the perfect choice for these applications. The inner chamber as well as the furnace front in the clean room will be especially designed for lowest particle contamination.

Please contact us if you are looking for a heat treatment solution under clean room conditions. We would be pleased to quote for the oven or furnace model that meets best your requirements.



KTR 8000 designed as a production furnace in the clean room with filters for air circulation



Air circulation chamber furnace NAC 120/65 with clean room specs



Air circulation furnace NAC 250/65 for clean room Class 100 with charging door to the clean room



Hot-wall retort furnace NRA 1700/06 with charging frame for installation in grey room with charging door in clean room

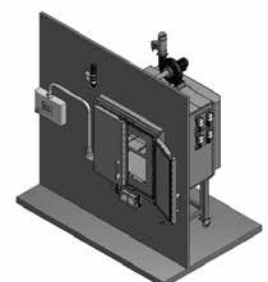

Clean/Grey room solution with charging and operating in clean room

## Compact Tube Furnaces



RD 30/200/11



Over-temperature limiter

### RD 30/200/11 - RD 30/200/13

The RD tube furnaces convince with their unbeatable price-performance ratio, very compact outer dimensions and their low weight. These all-rounders are equipped with a working tube which also serves as support for the heating wires. Thus, the working tube is part of the furnace heating which has the advantage that the furnaces achieve very high heat-up rates. The tube furnaces can be supplied for 1100 °C or 1300 °C.

Both models are designed for horizontal application. If the customer requires protective gas atmosphere, a separate working tube incl. gas supply system 1, e.g. made of quartz glass, must be inserted in the working tube.

- Tmax 1100 °C or 1300 °C
- Housing made of sheets of textured stainless steel
- Inner diameter of the tube: 30 mm, heated length: 200 mm
- Working tube made of C 530 material including two fiber plugs as standard
- Thermocouple type K (1100 °C) or type S (1300 °C)
- Solid state relays provide for low-noise operation of the heating
- Heating wires wound directly around the working tube resulting in very fast heat-up rates
- Defined application within the constraints of the operating instructions
- Controls description see page 60

#### Additional equipment

- Over-temperature limiter with adjustable cutout temperature for thermal protection class 2 in accordance with EN 60519-2 as temperature limiter to protect the furnace and load
- Gas supply system for non-flammable protective or reactive gas

Model	Tmax °C <sup>1</sup>	Outer dimensions in mm			Inner tube Ø mm	Heated length /mm	Length constant temperature +/- 5 K in mm <sup>1</sup>	Connected load kW	Minutes to Tmax <sup>2</sup>	Electrical connection <sup>*</sup>	Weight in kg
		W	D	H							
RD 30/200/11	1100	350	200	350	30	200	65	1.5	20	1-phase	12
RD 30/200/13	1300	350	200	350	30	200	65	1.5	25	1-phase	12

<sup>1</sup>Values outside the tube. Temperature inside the tube up to + 30 K.

<sup>2</sup>If connected at 230 V 1/N/PE resp. 400 V 3/N/PE

<sup>\*</sup>Please see page 60 for more information about supply voltage



R 170/1000/13



R 50/250/13 with gas supply system 2

**R 50/250/12 - R 170/1000/13, single-zoned, three-zoned**

These compact tube furnaces with integrated control systems can be used universally for many processes. Equipped with a standard working tube of C 530 ceramic and two fiber plugs, these tube furnaces have an unbeatable price/performance ratio.

- Tmax 1200 °C or 1300 °C
- Single-zoned design as standard
- Dual shell housing made of sheets of textured stainless steel
- Outer tube diameter of 50 to 170 mm, heated length from 250 to 1000 mm
- Working tube of C 530 ceramic including two fiber plugs as standard equipment
- Tmax 1200 °C: Type N thermocouple
- Tmax 1300 °C: Type S thermocouple
- Solid state relays provide for lownoise operation
- Standard working tube see chart on page 43
- Defined application within the constraints of the operating instructions
- Controls description see page 60

**Additional equipment**

- Over-temperature limiter with adjustable cutout temperature for thermal protection class 2 in accordance with EN 60519-2 as temperature limiter to protect the furnace and load
- Charge control with temperature measurement in the working tube and in the furnace chamber outside the tube see page 46
- Three-zoned design (heated length from 500 mm)
- Working tubes see chart on page 43
- Please see page 44 for additional equipment
- Gas supply systems for protective gas or vacuum operation see page 44
- Process control and documentation with Controltherm MV software package see page 63

Model	Tmax °C <sup>3</sup>	Outer dimensions in mm			Outer tube Ø /mm	Heated length mm	Length constant temperature +/- 5 K in mm <sup>3</sup>		Tube length in mm	Connected load kW	Electrical connection*	Weight in kg
		W <sup>1</sup>	D	H			single-zoned	three-zoned				
R 50/250/12	1200	434	340	508	50	250	80	-	450	1.6	1-phase	22
R 50/500/12	1200	670	340	508	50	500	170	250	700	2.3 <sup>4</sup>	1-phase	34
R 120/500/12	1200	670	410	578	120	500	170	250	700	6.5	3-phase <sup>2</sup>	44
R 170/750/12	1200	920	460	628	170	750	250	375	1070	10.0	3-phase <sup>2</sup>	74
R 170/1000/12	1200	1170	460	628	170	1000	330	500	1400	11.5	3-phase <sup>2</sup>	89
R 50/250/13	1300	434	340	508	50	250	80	-	450	1.6	1-phase	22
R 50/500/13	1300	670	340	508	50	500	170	250	700	2.3 <sup>4</sup>	1-phase	34
R 120/500/13	1300	670	410	578	120	500	170	250	700	6.5	3-phase <sup>2</sup>	44
R 170/750/13	1300	920	460	628	170	750	250	375	1070	10.0	3-phase <sup>2</sup>	74
R 170/1000/13	1300	1170	460	628	170	1000	500	500	1400	11.5	3-phase <sup>2</sup>	89

<sup>1</sup>Without tube

<sup>2</sup>Heating only between two phases (single-zoned design)

<sup>3</sup>Values outside the tube. Temperature inside the tube up to + 30 K.

\*Please see page 60 for more information about supply voltage

<sup>4</sup>Only valid for single-zone version

## Tube Furnaces with Stand for Horizontal or Vertical Operation



RT 50-250/11



RT 50-250/13

### RT 50-250/11 - RT 30-200/15

These compact tube furnaces are used when laboratory experiments must be performed horizontally, vertically, or at specific angles. The ability to configure the angle of tilt and the working height, and their compact design, also make these tube furnaces suitable for integration into existing process systems.

- Tmax 1100 °C, 1300 °C, or 1500 °C
- Compact design
- Vertical or horizontal operation freely adjustable
- Working height freely adjustable
- Working tube made of C 530 ceramic
- Type S thermocouple
- Operation also possible separate from stand if safety guidelines are observed
- Control system integrated in furnace base
- Please see page 44 for additional equipment
- Defined application within the constraints of the operating instructions
- Controls description see page 60

Model	Tmax °C	Outer dimensions in mm			Inner tube Ø /mm	Heated length mm	Length constant temperature +/- 5 K in mm <sup>1</sup>	Tube length in mm	Connected load kW	Electrical connection*	Weight in kg
		W <sup>1</sup>	D	H							
RT 50-250/11	1100	350	380	740	50	250	80	360	1.8	1-phase	25
RT 50-250/13	1300	350	380	740	50	250	80	360	1.8	1-phase	25
RT 30-200/15	1500	445	475	740	30	200	70	360	1.8	1-phase	45

<sup>1</sup>Values outside the tube. Temperature inside the tube up to + 30 K.

\*Please see page 60 for more information about supply voltage

## High-Temperature Tube Furnaces with SiC Rod Heating Gas Atmosphere or Vacuum



RHTC 80-450/15 with manual gas supply system

### RHTC 80-230/15 - RHTC 80-710/15

These compact tube furnaces with SiC rod heating and integrated switchgear and controller can be used universally for many processes. With an easy to replace working tube as well as additional standard equipment options, these furnaces are flexible and can be used for a wide range of applications. The high-quality fiber insulation ensures fast heating and cooling times. The SiC heating rods installed parallel to the working tube ensure excellent temperature uniformity. The price-performance ratio for this temperature range is unbeatable.

- Tmax 1500 °C
- Housing made of sheets of textured stainless steel
- High-quality fiber insulation
- Active cooling of housing for low surface temperatures
- Type S thermocouple
- Solid state relays provide for low-noise operation
- Prepared for assembly of working tubes with water-cooled flanges
- Ceramic tube, C 799 quality
- Standard working tube see chart on page 43
- Defined application within the constraints of the operating instructions
- Controls description see page 60

#### Additional equipment

- Over-temperature limiter with adjustable cutout temperature for thermal protection class 2 in accordance with EN 60519-2 as temperature limiter to protect the furnace and load
- Charge control with temperature measurement in the working tube and in the furnace chamber outside the tube see page 46
- Fiber plugs
- Check valve at gas outlet avoids intrusion of false air
- Working tubes for operation with water-cooled flanges
- Display of inner tube temperature with additional thermocouple
- Alternative gas supply systems for protective gas or vacuum operation see page 44
- Alternative working tubes see chart on page 43



RHTC 80-230/15



SiC rod heating

Model	Tmax °C <sup>3</sup>	Outer dimensions in mm			Outer tube Ø/ mm	Heated length/ mm	Length constant temperature +/- 5 K in mm <sup>3</sup>	Tube length in mm	Connected load kW	Electrical connection*	Weight in kg
		W	D	H							
RHTC 80-230/15	1500	600	430	580	80	230	80	600	7.5	3-phase <sup>2</sup>	50
RHTC 80-450/15	1500	820	430	580	80	450	150	830	11.3	3-phase <sup>1</sup>	70
RHTC 80-710/15	1500	1070	430	580	80	710	235	1080	13.8	3-phase <sup>1</sup>	90

<sup>1</sup>Heating only between two phases

<sup>2</sup>Heating only between phase 1 and neutral

\*Please see page 60 for more information about supply voltage  
<sup>3</sup>Values outside the tube. Temperature inside the tube up to + 30 K.



## High-Temperature Tube Furnaces for Horizontal and Vertical Operation up to 1800 °C Gas Atmosphere or Vacuum



RHTH 120/600/17

**RHTH 50/150/.. - RHTH 120/600/..,  
RHTV 50/150/.. - RHTV 120/600/..**

The high-temperature tube furnaces are available in either horizontal (type RHTH) or vertical (type RHTV) designs. High-quality insulation materials made of vacuum-formed fiber plates enable energy-saving operation and a fast heating time due to low heat storage and heat conductivity. By using different gas supply systems, operations can be performed under non-flammable or flammable protective or reactive gases or under vacuum.

- Tmax 1600 °C, 1700 °C, or 1800 °C
- MoSi<sub>2</sub> heating elements, mounted vertically for easy replacement
- Insulation with vacuum-formed ceramic fiber plates
- Rectangular outer housing with slots for convection cooling
- Models RHTV with hinges for wall mounting
- Housing made of sheets of textured stainless steel
- Ceramic working tube made of material C 799 incl. fiber plugs operation under air
- Type B thermocouple
- Power unit with low-voltage transformer and thyristor
- Over-temperature limiter with adjustable cutout temperature for thermal protection class 2 in accordance with EN 60519-2 as temperature limiter to protect the furnace and load and with selectable maximum temperature gradient as tube protection
- Switchgear and control unit separate from furnace in separate floor standing cabinet
- Standard working tube see chart on page 43
- Defined application within the constraints of the operating instructions
- Controls description see page 60

### Additional equipment

- Charge control with temperature measurement in the working tube and in the furnace chamber outside the tube see page 46



RHTV 50/150/17 vertical tube furnace  
with stand and gas supply system 2 as  
additional equipment

- Display of inner tube temperature with additional thermocouple
- Gas tight flanges for protective gas and vacuum operation
- Manual or automatic gas supply system
- Three-zone control for optimization of temperature uniformity (only RHTH)
- Check valve at gas outlet avoids intrusion of false air
- Stand for vertical operation
- Alternative working tubes designed for process requirements see chart on page 43
- Please see page 44 for more additional equipment



RHTV 120/480/16 LBS with working tube closed at one side, protective gas and vacuum option as well as with electric screw drive of the lift table



RHTH 120/600/18



Over-temperature limiter

Model	Tmax °C <sup>3</sup>	Outer dimensions in mm			Max. outer tube Ø /mm	Heated length mm	Length constant temperature +/- 5 K in mm <sup>3</sup>	Tube length in mm	Connected load kW	Electrical connection*	Weight in kg
		W <sup>2</sup>	D	H							
Horizontal design											
RHTH 50/150/..	1600 or	470	550	640	50	50	380	5.4	3-phase <sup>1</sup>	70	
RHTH 80/300/..	1700 or	620	550	640	80	100	530	9.0	3-phase <sup>1</sup>	90	
RHTH 120/600/..	1800	920	550	640	120	200	830	14.4	3-phase <sup>1</sup>	110	

Model	Tmax °C <sup>3</sup>	Outer dimensions in mm			Max. outer tube Ø /mm	Heated length mm	Length constant temperature +/- 5 K in mm <sup>3</sup>	Tube length in mm	Connected load kW	Electrical connection*	Weight in kg
		W	D	H <sup>2</sup>							
Vertical design											
RHTV 50/150/..	1600 or	570	650	510	50	30	380	5.4	3-phase <sup>1</sup>	70	
RHTV 80/300/..	1700 or	570	650	660	80	80	530	10.3	3-phase <sup>1</sup>	90	
RHTV 120/600/..	1800	570	650	960	120	170	830	19.0	3-phase <sup>1</sup>	110	

<sup>1</sup>Heating only between two phases  
<sup>2</sup>Without tube

\*Please see page 60 for more information about supply voltage  
<sup>3</sup>Values outside the tube. Temperature inside the tube up to - 50 K.

# Split-Type Tube Furnaces for Horizontal or Vertical Operation up to 1300 °C Gas Atmosphere or Vacuum



RS 80/500/11 with gas supply system 1



RS 80/750/13 with stand as additional equipment for vertical operation

## RS 80/300/11 - RS 170/1000/13

The tube furnaces of the product line RS can be used for horizontal as well as for vertical operation. The split-type design makes it easy to change the working tube. It allows for a comfortable exchange of various working tubes (e.g. working tubes made of different materials).

Using the wide range of accessories these professional tube furnaces can be optimally tailored to your process. By upgrading the furnaces with different gas supply systems the operation in a protective gas atmosphere, under vacuum or under flammable protective or reactive gases is possible. Besides convenient standard controllers for process control modern PLC control systems are also available.



Gas supply system for non-flammable protective or reactive gas with shutoff valve and flow meter with regulator valve, piped and ready to connect

- Tmax 1100 °C or 1300 °C
- Housing made of sheets of textured stainless steel
- Tmax 1100 °C: Type K thermocouple
- Tmax 1300 °C: Type S thermocouple

Model	Tmax °C <sup>5</sup>	Outer dimensions <sup>3</sup> in mm			Max. outer tube Ø /mm	Heated length mm	Length constant temperature +/- 5 K in mm <sup>5</sup>	Tube length in mm	Connected load kW	Electrical connection*	Weight in kg
		W <sup>2</sup>	D	H							
RS 80/300/11	1100	555	475	390	80	300	100	650	1.8	1-phase	80
RS 80/500/11	1100	755	475	390	80	500	170	850	3.4	1-phase	90
RS 80/750/11	1100	1005	475	390	80	750	250	1100	4.6	3-phase <sup>4</sup>	105
RS 120/500/11	1100	755	525	440	120	500	170	850	4.8	3-phase <sup>4</sup>	95
RS 120/750/11	1100	1005	525	440	120	750	250	1100	6.3	3-phase <sup>4</sup>	110
RS 120/1000/11	1100	1255	525	440	120	1000	330	1350	9.0	3-phase <sup>4</sup>	125
RS 170/750/11	1100	1005	575	490	170	750	250	1100	7.0 <sup>6</sup>	3-phase <sup>4</sup>	115
RS 170/1000/11	1100	1255	575	490	170	1000	330	1350	9.0 <sup>6</sup>	3-phase <sup>4</sup>	130
RS 80/300/13	1300	555	475	390	80	300	100	650	3.6	1-phase	80
RS 80/500/13	1300	755	475	390	80	500	170	850	6.0	3-phase <sup>4</sup>	90
RS 80/750/13	1300	1005	475	390	80	750	250	1100	9.3	3-phase <sup>4</sup>	105
RS 120/500/13	1300	755	525	440	120	500	170	850	7.8	3-phase <sup>4</sup>	95
RS 120/750/13	1300	1005	525	440	120	750	250	1100	12.6	3-phase <sup>4</sup>	110
RS 120/1000/13	1300	1255	525	440	120	1000	330	1350	12.6	3-phase <sup>4</sup>	125
RS 170/750/13	1300	1005	575	490	170	750	250	1100	12.6	3-phase <sup>4</sup>	115
RS 170/1000/13	1300	1255	575	490	170	1000	330	1350	12.6	3-phase <sup>4</sup>	130

<sup>1</sup>Heating only between two phases

<sup>2</sup>Without tube

<sup>3</sup>Outer dimensions for vertical operation upon request

<sup>4</sup>Heating only between phase 1 and neutral

<sup>5</sup>Values outside the tube. Temperature inside the tube up to + 30 K.

<sup>6</sup>Only valid for single-zone version

\*Please see page 60 for more information about supply voltage



- Frame for vertical operation, which can also be retrofitted as additional equipment
- Split-type design for simple insertion of the working tube
- Working tube made of ceramic C 530 for operation in air included in scope of delivery
- Switchgear and control unit separate from furnace in own wall or standing cabinet
- Standard working tube see chart on page 43
- Defined application within the constraints of the operating instructions
- Controls description see page 60

RS 120/1000/13S with gas tight tube, charge control and check valve at gas outlet

#### Additional equipment

- Charge control with temperature measurement in the working tube and in the furnace chamber outside the tube see page 46
- Display of inner tube temperature with additional thermocouple
- Different gas supply systems (page 44) for non-flammable or flammable protective or reactive gases and vacuum operation
- Three-zone control for optimization of temperature uniformity
- Check valve at gas outlet avoids intrusion of false air
- Ceramic half pipe for heating elements and/or as support surface for the load
- Optical temperature measurement for the use as lab strand annealing furnace
- Stand for vertical operation
- Base frame with integrated switchgear and controller
- Alternative working tubes designed for process requirements see chart on page 43
- Please see page 44 for more additional equipment



Quartz glass and flanges for protective gas operation as optional equipment

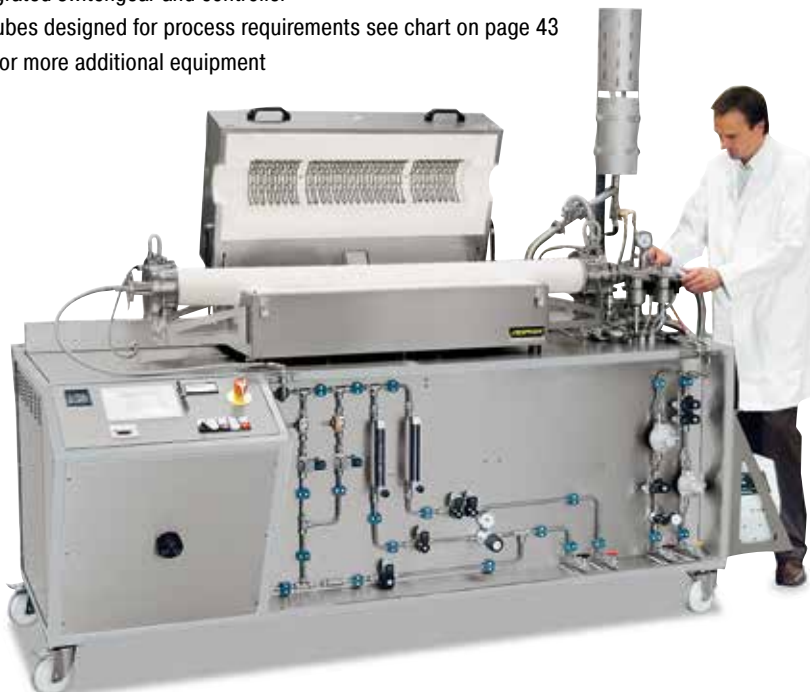

Optical temperature measurement for the use as lab strand annealing furnace

RS 120/750/13 with gas supply system 4, hydrogen applications



## Rotary Tube Furnaces for Batch Operation up to 1100 °C



Rotary tube furnace RSRB 120/750/11 as tabletop version for batch operation



Connection set for vacuum operation



Gas tight closing plug for tubes made of silica glass closed at one side

### RSRB 80-500/11 - RSRB 120-1000/11

The rotary tube furnaces of the RSRB series are ideally suited for batch operation. The permanent rotation of the working tube ensures that the charge is constantly in motion. Due to the special shape of the quartz reactor with the tapered pipe ends the batch is kept in the rotary tube furnace and can be heat-treated an arbitrarily long time period time; a controlled heating to the temperature profiles is also possible.

- Tmax 1100 °C
- Thermocouple type K
- Housing made of sheets of textured stainless steel
- Furnace designed as table-top model with quartz glass reactor which opens on both sides, tapered ends
- Reactor is removed for emptying out of the rotary tube furnace. Beltless drive and hinged furnace housing (opening temperature < 180 °C) provide for very easy removal through
- Adjustable drive of approx. 2-45 rpm
- Switchgear and control unit separate from furnace in own wall or standing cabinet
- Defined application within the constraints of the operating instructions
- Controls description see page 60

#### Additional equipment

- Three-zone control for the optimization of temperature uniformity
- Temperature display unit in the working tube with measurement by means of an additional thermocouple
- Charge control by means of an additional thermocouple in the working tube
- Different gassing ensures good flushing of the charge with process gas through inlet on one side and outlet on other side of tube





RSRB 120/500/11



Rotary tube furnace tilted towards the right side for charging and batch operation

- Gas-tight rotary feedthrough for connection of the rotating reactor to a gas supply system
- Check valve at gas outlet avoids intrusion of false air
- Vacuum design, up to  $10^{-2}$  mbar depending on the applied pump
- Open on both sides reactor made of quartz glass with knobs for better mixing of the charge in the tube
- Package for improved charging and discharging of the working tube in the following design:
  - Mixing reactor made of quartz glass with integrated blade for better mixing of the batch, closed on one side, large opening on the other side
  - Tilting mechanism to the left/to the right. For charging and heat treatment, the furnace is tilted towards the right side until the stop so that the load is charged into the furnace. For discharge, the furnace is tilted towards the other side to discharge the powder from the reactor. It is no longer necessary to remove the reactor.
  - Furnace assembled on base with integrated switchgear and controller, incl. transport casters



Rotary tube furnace tilted towards the left side to discharge

Model	Tmax °C <sup>3</sup>	Outer dimensions in mm			Max. outer tube Ø/ mm	Ø Terminal end	Heated length mm	Length constant Temperature +/- 5 K in mm <sup>2</sup>		Tube length in mm	Connected load/ kW	Electrical connection*	Weight in kg
		W	D	H				single zoned	three zoned				
RSRB 80-500/11	1100	1145	475	390	76	28	500	170	250	1140	3,7	1-phase	100
RSRB 80-750/11	1100	1395	475	390	76	28	750	250	375	1390	4,9	3-phase <sup>2</sup>	115
RSRB 120-500/11	1100	1145	525	440	106	28	500	170	250	1140	5,1	3-phase <sup>2</sup>	105
RSRB 120-750/11	1100	1395	525	440	106	28	750	250	375	1390	6,6	3-phase <sup>1</sup>	120
RSRB 120-1000/11	1100	1645	525	440	106	28	1000	330	500	1640	9,3	3-phase <sup>1</sup>	125

<sup>1</sup>Heating only between two phases

<sup>2</sup>Heating only between phase 1 and neutral

\*Please see page 60 for more information about supply voltage

<sup>3</sup>Values outside the tube. Temperature inside the tube up to + 30 K.

## Rotary Tube Furnaces for Continuous Processes up to 1300 °C



### RSRC 80-500/11 - RSRC 120-1000/13

The RSRC rotary tube furnaces are particularly suitable for processes where continuously running batch material is heated for a short time.

The rotary tube furnace is positioned slightly inclined heated-up to the target temperature. The material is then continuously supplied at the upper end of the tube. It passes through the

heated area of the tube and falls on the lower end out of the tube. The time of heat treatment results from the inclination angle, the rotational speed and the length of the working tube, as well as from the flow properties of the batch material.

RSRC 120/1000/13 for continuous operation

Equipped with the optional closed loading system for 5 liter charge material incl. receptacle, the furnace can also be used for processes under protective gas or vacuum.

Depending on process, charge and required maximum temperature, different working tubes made of quartz glass, ceramics or metal to be used (see page 42). This rotary tube furnace is therefore highly adaptable for different processes.



Screw-conveyor with adjustable speed



Screw-conveyors with different pitches for the adaption to the charge

- Tmax 1100 °C
  - Working tube made of quartz glass open at both sides
  - Thermocouple type K
- Tmax 1300 °C
  - Open tube made of ceramics C 530
  - Thermocouple type S
- Housing made of sheets of textured stainless steel
- Adjustable drive of approx. 2-45 rpm
- Digital display unit for the tilting angle of the furnace
- Beltless drive and split-type furnace housing (opening temperature < 180 °C) provide for very easy tube removal
- Compact system, rotary tube furnace positioned on a base frame with
  - manual spindle drive with crank to preset the tilting angle
  - switchgear and controls integrated
  - castors
- Defined application within the constraints of the operating instructions
- Controls description see page 60



RSRC 120/750/11 with charging funnel and collection bottle at the outlet

### Additional equipment

- Three-zone control for the optimization of temperature uniformity
- Temperature display unit in the working tube with measurement by means of an additional thermocouple
- Charge control by means of an additional thermocouple in the working tube
- Different gassing systems with good flushing of the charge with process gas in counterflow (only in combination with feeding system below)
- Check valve at gas outlet avoids intrusion of false air
- Vacuum design, up to  $10^{-2}$  mbar depending on the applied pump
- Charging system for continuous material transport, consisting of:
  - Stainless steel funnel incl. electric vibration generator to optimize the material feeding into the working tube
  - Electrically driven screw-conveyor at the inlet of the working tube with 10, 20 or 40 mm pitch and adjustable speed between 0.28 and 6 revolutions per minute, different gear transmissions for other speeds on request
  - Collecting bottle made of laboratory glass at the outlet of the working tube
  - Suitable for operation in gas atmosphere or vacuum
- Working tubes made of different materials see page 42
- Quartz glass batch reactors,  $T_{max}$  1100 °C
- Higher temperatures up to 1600 °C available on request
- Digital display unit for the tilting angle of the furnace
- Electric linear drive for the adjustment of the tilting angle
- PLC controls for temperature control and the control of connected aggregates such as gearshift and speed of the screw-conveyor, speed of the working tube, switching of the vibration generator, etc.



Adapters for alternative operation with working tube or process reactor



Vibration generator at the charging funnel for improved powder supply

Model	Tmax °C <sup>3</sup>	Outer dimensions in mm			Max. outer tube Ø/ mm	Ø Terminal end <sup>4</sup>	Heated length mm	Length constant Temperature +/- 5 K in mm <sup>3</sup>		Tube length in mm	Connected load/ kW	Electrical connection*	Weight in kg
		W	D	H				single zoned <sup>1</sup>	three zoned				
RSRC 80-500/11	1100	2505	1045	1655	80	28	500	170	250	1540	3,7	1-phase	555
RSRC 80-750/11	1100	2755	1045	1655	80	28	750	250	375	1790	4,9	3-phase <sup>2</sup>	570
RSRC 120-500/11	1100	2505	1045	1715	110	28	500	170	250	1540	5,1	3-phase <sup>2</sup>	585
RSRC 120-750/11	1100	2755	1045	1715	110	28	750	250	375	1790	6,6	3-phase <sup>1</sup>	600
RSRC 120-1000/11	1100	3005	1045	1715	110	28	1000	330	500	2040	9,3	3-phase <sup>1</sup>	605
RSRC 80-500/13	1300	2505	1045	1655	80	28	500	170	250	1540	6,3	3-phase <sup>1</sup>	555
RSRC 80-750/13	1300	2755	1045	1655	80	28	750	250	375	1790	9,6	3-phase <sup>1</sup>	570
RSRC 120-500/13	1300	2505	1045	1715	110	28	500	170	250	1540	8,1	3-phase <sup>1</sup>	585
RSRC 120-750/13	1300	2755	1045	1715	110	28	750	250	375	1790	12,9	3-phase <sup>1</sup>	600
RSRC 120-1000/13	1300	3005	1045	1715	110	28	1000	330	500	2040	12,9	3-phase <sup>1</sup>	605

<sup>1</sup>Heating only between two phases

<sup>2</sup>Heating only between phase 1 and neutral

<sup>3</sup>Values outside the tube. Temperature inside the tube up to + 30 K.

\*Please see page 60 for more information about supply voltage

<sup>4</sup>only for reactors

## Working Tubes



Various working tubes as option

There are various working tubes available, depending on application and temperatures. The technical specifications of the different working tubes are presented in the following table:

Material	Tube outside Ø mm	Max. heat-up ramp K/h	Tmax in air* °C	Tmax in vacuum operation °C	Gas tight
C 530 (Sillimantín) <sup>1</sup>	< 120	unlimited	1300	not possible	no
	from 120	200			
C 610 (Pythagoras) <sup>1</sup>	< 120	300	1400	1200	yes
	from 120	200			
C 799 (99.7 % Al <sub>2</sub> O <sub>3</sub> ) <sup>1</sup>	< 120	300	1800	1400	yes
	from 120	200			
Quartz glass	all	unlimited	1100	950	yes
CrFeAl-Alloy	all	unlimited	1300	1100	yes

\*The max. allowed temperature might be reduced operating under aggressive atmospheres

<sup>1</sup>Tolerances with respect to form and position acc. to DIN 40680

## Working Tubes for Rotary Tube Furnaces: Standard (●) and Options (○)

Measurements outer Ø x inner Ø x length	Article No. <sup>1</sup>		Rotary tube furnace, continuous operation					Batch operation										
	work tube	spare tube	RSRC					RSRB										
			1100 °C		1300 °C			1100 °C										
			80-500	80-750	120-500	120-750	120-1000	80-500	80-750	120-500	120-750	120-1000	80-500	80-750	120-500	120-750	120-1000	
<b>Ceramic tube C 530</b>																		
80 x 65 x 1540 mm	601405318	691404536	○					●										
80 x 65 x 1790 mm	601405319	691404537		○		○			●		○							
80 x 65 x 2040 mm	601404701	691404538					○					○						
110 x 95 x 1540 mm	601405320	691404539			○					●								
110 x 95 x 1790 mm	601405321	691403376				○					●							
110 x 95 x 2040 mm	601405322	691404540					○					●						
<b>Ceramic tube C 610</b>																		
80 x 65 x 1540 mm	601405313	691404541	○					○										
80 x 65 x 1790 mm	601405314	691404542		○		○			○		○							
80 x 65 x 2040 mm	601404707	691404543					○					○						
110 x 95 x 1540 mm	601405315	691404544			○					○								
110 x 95 x 1790 mm	601405316	691404561				○					○							
110 x 95 x 2040 mm	601405317	691403437					○					○						
<b>Quartz glass tube</b>																		
76 x 70 x 1540 mm	601405308	691404545	●					○		○								
76 x 70 x 1790 mm	601405309	691404546		●		○			○		○							
76 x 70 x 2040 mm	601404713	691404547					○					○						
106 x 100 x 1540 mm	601405310	691403519			●					○								
106 x 100 x 1790 mm	601405311	691403305				●					○							
106 x 100 x 2040 mm	601405312	691404548					●					○						
<b>Quartz glass tube with pimple</b>																		
76 x 70 x 1540 mm	601405301	691404549	○					○										
76 x 70 x 1790 mm	601405304	691404550		○		○			○		○							
76 x 70 x 2040 mm	601404719	691404551					○					○						
106 x 100 x 1540 mm	601405305	691404552			○					○								
106 x 100 x 1790 mm	601405306	691403442				○					○							
106 x 100 x 2040 mm	601405307	691404553					○					○						
<b>CrFeAl-Alloy</b>																		
75 x 66 x 1540 mm	601405296	691405357	○		○			○		○								
75 x 66 x 1790 mm	601405297	691405231		○	○				○		○							
109 x 99 x 1540 mm	601405298	691403682			○					○								
109 x 99 x 1790 mm	601405299	691403607				○					○							
109 x 99 x 2040 mm	601405300	691405122					○					○						
<b>Quartz glass reactor</b>																		
76 x 70 x 1140 mm	601402746	691402548											●		○			
76 x 70 x 1390 mm	601402747	691402272												●			○	
106 x 100 x 1140 mm	601402748	691402629													●			
106 x 100 x 1390 mm	601402749	691402638														●		
<b>Quartz glass reactor with pimples</b>																		
76 x 70 x 1140 mm	601404723	691402804											○		○			
76 x 70 x 1390 mm	601404724	691403429												○		○		
106 x 100 x 1140 mm	601404725	691403355													○		○	
106 x 100 x 1390 mm	601404726	691403296														○		○
<b>Quartz glass mixing reactor</b>																		
76 x 70 x 1140 mm	601404727	691403407											○					
76 x 70 x 1390 mm	601404728	691404554												○				
106 x 100 x 1140 mm	601404732	691404557													○			
106 x 100 x 1390 mm	601404733	691404558														○		

● Standard working tube

○ Working tube available as an option

<sup>1</sup>Tubes/reactors incl. mounted sleeves for connection to the rotary drive. Spare tubes come without sleeves.





## Gas Supply Systems/Vacuum Operation for Tube Furnaces



Gas supply system 1:  
Fiber plugs with protective gas connection,  
suitable for many laboratory applications



Water-cooled stainless steel flange



Gas supply system for non-flammable protective or reactive gas with shutoff valve and flow meter with regulator valve, piped and ready to connect



Observation window as additional equipment for gas tight flanges

When equipped with various equipment packages, the tube furnace product lines can be adapted for operation with nonflammable or flammable gasses or for vacuum operation.

### Gas Supply System 1 for non-flammable protective or reactive gases Not gastight, no vacuum operation

This package represents a basic version sufficient for many applications, for operation with non-flammable protective or reactive gasses. The standard working tube made of ceramic C 530 delivered with the furnace can still be used.

- Available for tube furnaces RD, R, RT and RS
- Standard working tube can be used
- 2 plugs made of porous, non-classified ceramic fiber incl. protective gas connections
- Gas supply system for nonflammable protective gas (Ar, N<sub>2</sub>, forming gas, others on request) with shutoff valve and flow meter with control valve (volume 50-500 l/hr), piped and ready to connect. One gas intake pressure at 300 mbar to be provided by customer.

#### Additional equipment

- Extension of gas supply system with a second or third nonflammable type of gas
- Bottle pressure regulator for use with bottled gas
- Automatic switching on/off by means of the program segments of the controller, only possible with control systems which include programmable extra functions

### Gas Supply System 2 for non-flammable protective or reactive gases/vacuum operation

For increased atmospheric purity requirements in the working tube, we recommend this gas supply system. The system can also be equipped for vacuum operation.

- Available for tube furnaces R, RS, RSRB, RSRC, RHTC, RHTH, RHTV
- Gas supply system for nonflammable protective gas (Ar, N<sub>2</sub>, forming gas, others on request) with shutoff valve and flow meter with control valve (volume 50-500 l/hr), piped and ready to connect. One gas intake pressure at 300 mbar to be provided by customer.
- Additional equipment for static tube furnaces:
  - Longer, gas tight working tube of ceramic C 610 for furnaces to 1300 °C or of C 799 for temperatures above 1300 °C
  - 2 vacuum-tight, water-cooled stainless steel flanges with fittings on the outlet side (cooling water supply with NW9 hose connector to be provided by the customer)
  - Mounting system on furnace for the flanges
- Additional equipment for RSRC models (continuous operation): charging system
- Additional Equipment for RSRB models: gas-tight rotarylead-outs on gas inlet and outlet, gas cooler and gas outlet valve

#### Additional equipment

- Extension of gas supply system with a second or third nonflammable type of gas
- Bottle pressure regulator for use with bottled gas
- Automatic switching on/off by means of the program segments of the controller, only possible with control systems which include programmable extra functions
- Gas-supply programmable via mass-flow controllers (only in combination with PLC-controls)
- Process tubes made of different materials
- Quick-locks for watercooled flanges
- Cooling unit for closed loop water circuit
- Window for charge observation in combination with gas tight flanges

\* Country-specific guidelines with respect to the possible gas mixing ration have to be considered

## Vacuum Operation

- Vacuum package for evacuation of the working tube, consisting of connector for the gas outlet, ball valve, manometer, manually operated rotary vane vacuum pump with corrugated stainless steel hose connected to the gas outlet, max. attainable end pressure in working tube depending on pump type
- Pumps for max. final pressure of up to  $10^{-5}$  mbar (models RSRB/RSRC up to  $10^{-2}$  mbar) on request see page 45
- The decrease in strength of the working tube at high temperatures limits the maximum operating temperature under vacuum see page 42

## Gas Supply System 4 for hydrogen, fully-automatic, unattended operation

Adding gas supply system 4 to the tube furnace allows operation under a hydrogen atmosphere. During hydrogen operation, a safety pressure of approx. 30 mbar is ensured in the working tube. Surplus hydrogen is burnt off in an exhaust gas torch. With extended safety logic and an integrated nitrogen purge container, the system can be used for fully-automatic, unattended operation. Equipped with a Safety-PLC control system, pre-purging, hydrogen inlet, operation, fault monitoring and purging at the end of the process are carried out automatically. In case of default, the tube is immediately purged with nitrogen and the system is automatically switched to a safe status.

- Available for tube furnaces RS, RSRC, RHTH and RHTV
- Safety system for operation with flammable gases including monitoring of torch function and overpressure
- Extended safety control system with emergency tube purging in case of default
- Emergency purge container
- Safety-PLC control system with touchpanel for data input
- Exhaust gas torch
- Pressure switch for monitoring the safety pressure
- Gas supply system for  $H_2$  and  $N_2$ . Volume adjustment is carried out by hand (the customer provides an  $H_2$  supply at 1 bar, an  $N_2$  supply at 10 bar, an  $O_2$  supply at 6-8 bar and a propan supply at 300 mbar)

### Additional equipment

- Gas supply system extension for additional nonflammable gas types
- Operation with other flammable gases on request
- Bottle pressure reducer for use with bottled gas
- Cooling unit for closed loop water circuit
- Vacuum packages (with hydrogen operation, this package can only be used for pre-evacuation)
- Gas supply via program-dependent, controllable mass flow controllers

## Vacuum Pumps

With respect to the final pressure different pumps are available see page 56:

- Single-step rotary piston pump for a max. final pressure of approx. 20 mbar.
- Two-step rotary piston pump for a max. final pressure of approx.  $10^{-2}$  mbar.
- Turbomolecular pump stand (rotary vane pump with following turbomolecular pump for a max. final pressure of  $10^{-5}$  mbar.
- Independent pressure gauge for a pressure range of  $10^{-3}$  mbar or  $10^{-9}$  mbar as additional equipment

Information:

For protection of the vacuum pump only cold stage evacuation is allowed.



RHTH 120-600/18 with gas supply system 4 for hydrogen operation

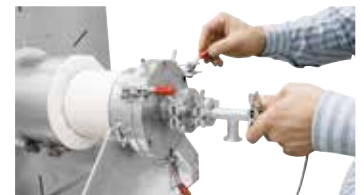

Water-cooled end flange with quick connectors as additional equipment



Vacuum pump stand for operation up to  $10^{-5}$  mbar



Independent pressure gauge for a pressure range of  $10^{-3}$  mbar or  $10^{-9}$  mbar

# Control Alternatives for Tube Furnaces

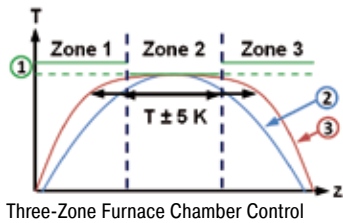

### Three-Zone Furnace Chamber Control

The temperature is measured by thermocouples positioned outside of the working tube, one in the middle and two on the sides. The outer zones are controlled with a setpoint-offset in relation to the middle zone. This allows the heat loss at the ends of the tube to be compensated to ensure an extended zone of constant temperature ( $\pm 5$  K).

### Furnace Chamber Control

with temperature measurement in furnace chamber outside the working tube.

- Advantages: Thermocouple protected against damage and aggressive load, very even control, attractive price
- Disadvantage: Temperature difference between displayed temperature on the controller and inside the tube

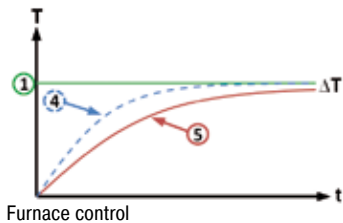

### Extension Package for Furnace Chamber Control

with additional temperature measurement in the working tube and display of the measured temperature

### Charge Control

with temperature measurement both in the furnace chamber outside the working tube as well as in the working tube.

- Advantages: Very precise and rapid control adjustment
- Disadvantage: Costs

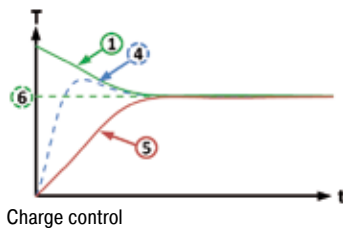

### Furnace Chamber vs. Charge Control Comparison

#### Furnace Chamber Control

Only the furnace chamber temperature is measured and controlled. Regulation is carried out slowly to avoid out-of-range values. As the charge temperature is not measured and controlled, it may vary a few degrees from the chamber temperature.

#### Charge Control

If the charge control is switched on, both the charge temperature and furnace chamber temperature are measured. By setting different parameters the heat-up and cooling processes can be individually adapted. This results in a more precise temperature control at the charge.

1. Furnace setpoint value
2. Actual value furnace chamber, 1-zone
3. Actual value furnace chamber, 3-zone
4. Actual value furnace chamber
5. Actual value load/bath/muffle/retort
6. Charge setpoint value

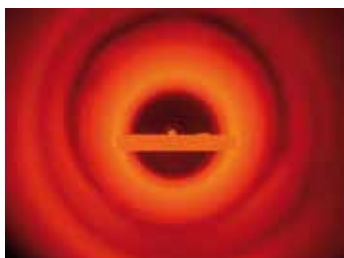

Sintering under hydrogen in a tube furnace of RHTH product line

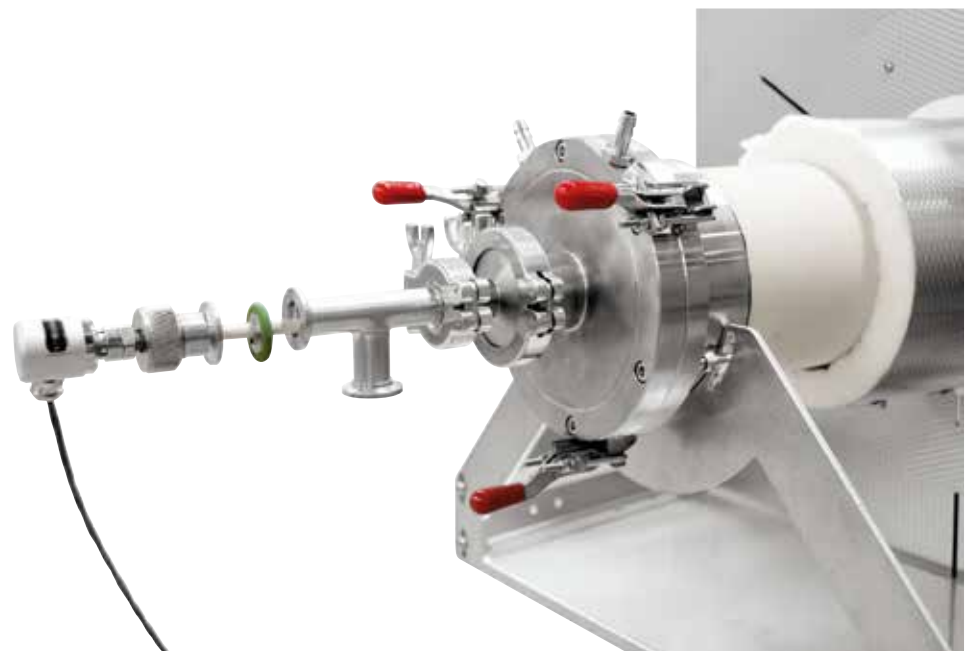

Thermocouple for charge control in the RHTH 120/600/18 furnace

## Customized Tube Furnaces



Rotary Tube Furnace RSR 250/3500/15S



RS 460/1000/16S for integration in a production plant

With their high level of flexibility and innovation, Nabertherm offers the optimal solution for customer-specific applications.

Based on our standard models, we develop individual solutions also for integration in overriding process systems. The solutions shown on this page are just a few examples of what is feasible. From working under vacuum or protective gas via innovative control and automation technology for a wide selection of temperatures, sizes, lengths and other properties of tube furnace systems – we will find the appropriate solution for a suitable process optimization.



RS 100/250/11S in split-type design for integration into a test stand



RS 120/1000/11S, three-zone controlled, incl. zone separators to reach a temperature gradient



RS 250/2500/11S, five-zone controlled, for wire annealing in high-vacuum or under protective gases, incl. forced cooling and exhaust hood



RS 120/1000/11S in divided version. Both half furnaces are manufactured identically and will be integrated in an existing gas-heating system with space-saving design



## Melting Furnaces



K2/10 as bale-out furnace with steel crucible for lead melting



KC 2/15

### K 1/10 - K 4/13, KC 1/15 + KC 2/15

These compact melting furnaces for the melting of non-ferrous metals and alloys are one of a kind and have a number of technical advantages. Designed as tabletop models, they can be used for many laboratory applications. The practical counter balanced hinge with shock absorbers and the spout (not for KC) on the front of the furnace make exact dosing easy when pouring the melt. The furnaces are available for furnace chamber temperatures of 1000, 1300, or 1500 °C. This corresponds to melt temperatures of about 80-110 °C lower.

- Tmax 1000 °C, 1300 °C, or 1500 °C, with melt temperature about 80 - 110 °C lower
- Crucible sizes of 1, 2, or 4 liters
- Crucible with integrated pouring spout of iso-graphite included with delivery
- Spout (not for KC), mounted at the furnace for exact pouring
- Compact bench-top design, simple emptying of crucible by tilting system with gas damper
- Crucible for heating up of melting furnace insulated with a hinged lid, lid opened when pouring
- Defined application within the constraints of the operating instructions
- Controls description see page 60

#### Additional equipment

- Other crucible types available, e.g. steel
- Design as bale-out furnace without tilting device, e.g. for lead melting
- Over-temperature limiter for the furnace chamber with automatic reset to protect against overtemperature. The limit controller switches off the heating when the pre-set limit temperature has been reached and does not switch it on again until the temperature falls below the setting again.
- Observation hole for melt

Model	Tmax °C	Crucible	Volume in l	Outer dimensions in mm			Connected load kW	Electrical connection*	Weight in kg
				W	D	H			
K 1/10	1000	A 6	1.0	520	680	660	3.0	1-phase	85
K 2/10	1000	A10	2.0	520	680	660	3.0	1-phase	90
K 4/10	1000	A25	4.0	570	755	705	3.6	1-phase	110
K 1/13 <sup>2</sup>	1300	A 6	1.0	520	680	660	3.0	1-phase	120
K 2/13 <sup>2</sup>	1300	A10	2.0	520	680	660	3.0	1-phase	125
K 4/13 <sup>2</sup>	1300	A25	4.0	570	755	705	5.5	3-phase <sup>1</sup>	170
KC 1/15 <sup>3</sup>	1500	A6	1.0	580	630	580	10.5	3-phase	170
KC 2/15 <sup>3</sup>	1500	A10	2.0	580	630	580	10.5	3-phase	170

<sup>1</sup>Heating only between two phases

\*Please see page 60 for more information about supply voltage

<sup>2</sup>Outer dimensions of furnace, transformer in separate housing (500 x 570 x 300 mm)

<sup>3</sup>Switchgear and controller mounted in a floor standing cabinet



KC 2/15



## Fast-Firing Furnaces

### LS 12/13 and LS 25/13

These fast-firing furnaces are ideal for simulation of typical fast-firing processes up to a maximum firing temperature of 1300 °C. The combination of high performance, low thermal mass and powerful cooling fans provides for cycle times from cold to cold of under 35 minutes.

- Tmax 1300 °C
- Very compact design
- Ceramic grid tubes as charge support
- Floor and lid heating
- Two-zone control, bottom and lid
- Integrated cooling fans, programmable to speed up charge cooling including housing cooling
- Programmable lid opening of approximately 20 mm for faster cooling without activating the fan
- Thermocouple PtRh-Pt, type S for top and bottom zone
- Castors for easy furnace moving
- Defined application within the constraints of the operating instructions
- Controls description see page 60

Model	Tmax °C	Inner dimensions in mm			Volume in l	Outer dimensions in mm			Connected load kW	Electrical connection*	Weight in kg
		w	d	h		W	D	H			
LS 12/13	1300	350	350	40	12	600	800	985	15	3-phase	130
LS 25/13	1300	500	500	100	25	750	985	1150	22	3-phase	160

\*Please see page 60 for more information about supply voltage



LS 25/13

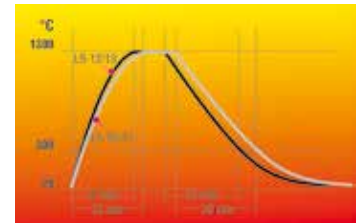

Firing curves LS 12/13 and LS 25/13

## Gradient or Lab Strand Annealing Furnaces

### GR 1300/13

The furnace chamber of the gradient furnace GR 1300/13 is divided in six control zones of equal length. The temperature in each of the six heating zones is separately controlled. The gradient furnace is usually charged from the side through the parallel swivel door. A maximum temperature gradient of 400 °C can then be stabilized over the heated length of 1300 mm. On request the furnace also is designed as a lab strand annealing furnace with a second door on the opposite side. Other available additional equipment consists of fiber chamber separators dividing the furnace chamber into six equally sized chambers. Charging then occurs from above by opening the large lid.

- Tmax 1300 °C
- Heated length: 1300 mm
- Heating elements on support tubes providing for free heat radiation in the kiln chamber
- Charging from the top or through the right side door
- Gas damper suspension of the lid
- 6-zone control
- Separate control of heating zones (each 160 mm long)
- Temperature gradient of 400 °C over the entire length of the kiln chamber, each zone can individually be controlled
- Defined application within the constraints of the operating instructions
- Controls description see page 60

#### Additional equipment

- Up to ten control zones
- Fiber separators dividing the chamber in six equally sized chambers
- Second parallel swivel door for use as lab strand annealing furnace
- Vertical instead of horizontal strand furnace

Model	Tmax °C	Inner dimensions in mm			Outer dimensions in mm			Connected load kW	Electrical connection*	Weight in kg
		w	d	h	W	D	H			
GR 1300/13	1300	1300	100	60	1660	740	1345	18	3-phase	300

\*Please see page 60 for more information about supply voltage



GR 1300/13



Furnace chamber of the GR 1300/13 with second door as additional equipment

## Hot-Wall Retort Furnaces up to 1100 °C



NRA 150/09 with automatic gas injection and process control H 3700



NRA 25/06 with gas supply system



Inside heating in models NRA ../06



Bayonet quick-lock for the retort, also with electric drive as additional equipment



Parallel guided door to open the hot furnace as additional equipment

### NRA 17/06 - NRA 1000/11

These gas tight retort furnaces are equipped with direct or indirect heating depending on temperature. They are perfectly suited for various heat treatment processes requiring a defined protective or a reaction gas atmosphere. These compact models can also be laid out for heat treatment under vacuum up to 600 °C. The furnace chamber consists of a gas tight retort with water cooling around the door to protect the special sealing. Equipped with the corresponding safety technology, retort furnaces are also suitable for applications under reaction gases, such as hydrogen or, in combination with the IDB package, for inert debinding or for pyrolysis processes.

Different model versions are available depending on the temperature range required for the process:

#### Models NRA ../06 with Tmax 650 °C

- Heating elements located inside the retort
- Temperature uniformity up to +/- 6 °C inside the work space from 100 °C - 600 °C see page 59
- Retort made of 1.4571
- Gas circulation fan in the back of the retort provides for optimal temperature uniformity

#### Models NRA ../09 with Tmax 950 °C

- Outside heating with heating elements around the retort
- Temperature uniformity up to +/- 6 °C inside the work space from 200 °C - 900 °C see page 59
- Retort made of 1.4841
- Fan in the back of the retort provides for optimal temperature uniformity

#### Models NR ../11 with Tmax 1100 °C

- Outside heating with heating elements around the retort
- Temperature uniformity up to +/- 8 °C inside the work space from 200 °C - 1050 °C see page 59
- Retort made of 1.4841



NRA 480/04S



NRA 50/09 H<sub>2</sub>

**Basic version**

- Compact housing in frame design with removable stainless steel sheets
- Controls and gas supply integrated in the furnace housing
- Welded charging supports in the retort or air-baffle box in the furnace with air circulation
- Swivel door hinged on right side with open cooling water system
- Depending on furnace volume for 950 °C- and 1100 °C-version the control system is divided in one or more heating zones
- Temperature control as furnace control with temperature measurement outside the retort
- Gas supply system for one non-flammable protective or reaction gas with flow meter and solenoid valve, switchable via the control system
- Operation under vacuum up to 600 °C with optional single-stage rotary vane pump
- Port for vacuum pump for cold evacuation
- Defined application within the constraints of the operating instructions
- Process control H 1700 (resp. P 330 for 650 °C-version) see page 60

**Additional equipment**

- Upgrade for other nonflammable gases
- Automatic gas injection, including MFC flow controller for alternating volume flow, controlled with process control H 3700
- Vacuum pump for evacuating of the retort up to 600 °C, attainable vacuum up to 10<sup>-5</sup> mbar subject to selected pump
- Cooling system for shortening process times
- Heat exchanger with closed-loop cooling water circuit for door cooling
- Measuring device for residual oxygen content
- Door heating
- Temperature control as charge control with temperature measurement inside and outside the retort



Vacuum pump for cold evacuation of the retort

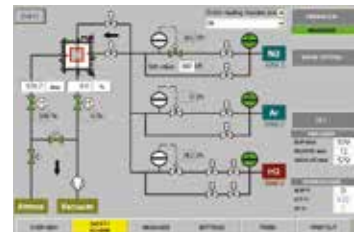

Process control H 3700 for automatic version



NRA 300/09 H<sub>2</sub> for heat treatment under hydrogen



Charging of the NRA 300/06 furnace with a pallet truck

### H<sub>2</sub> Version for Operation with Flammable Process Gases

When a flammable process gas like hydrogen is used, the retort furnace is additionally equipped with the required safety technology. Only certified and industry proven safety sensors are used. The furnace is controlled by a fail-safe PLC control system (S7- 300F/safety controller).

- Supply of flammable process gas at controlled overpressure of 50 mbar relative
- Certified safety concept
- Process control H 3700 with PLC controls and graphic touch panel for data input
- Redundant gas inlet valves for hydrogen
- Monitored pre-pressures of all process gases
- Bypass for safe flushing of furnace chamber with inert gas
- Torch for thermal afterburning of exhaust gases
- Emergency flood container for purging the furnace in case of failure

### IDB Version for Debinding under Non-flammable Protective Gases or for Pyrolysis Processes

The retort furnaces of the NR and NRA product line are perfectly suited for debinding under non-flammable protective gases or for pyrolysis processes. The IDB version of the furnaces implements a safety concept by controlled purging the furnace chamber with a protective gas. Exhaust gases are burned in an exhaust torch. Both the purging and the torch function are monitored to ensure a safe operation.

- Process control under monitored and controlled overpressure of 50 mbar relative
- Process control H 1700 with PLC controls and graphic touch panel for data input
- Monitored gas pre-pressure of the process gas
- Bypass for safe flushing of furnace chamber with inert gas
- Torch for thermal afterburning of exhaust gases



NR 150/11 IDB with thermal afterburning system

Model	Tmax °C	Model	Tmax °C	Work space dimensions in mm			Useful volume in l	Electrical connection*
				w	d	h		
NRA 17/..	650 or 950	NR 17/11	1100	225	350	225	17	3-phase
NRA 25/..	650 or 950	NR 25/11	1100	225	500	225	25	3-phase
NRA 50/..	650 or 950	NR 50/11	1100	325	475	325	50	3-phase
NRA 75/..	650 or 950	NR 75/11	1100	325	700	325	75	3-phase
NRA 150/..	650 or 950	NR 150/11	1100	450	750	450	150	3-phase
NRA 200/..	650 or 950	NR 200/11	1100	450	1000	450	200	3-phase
NRA 300/..	650 or 950	NR 300/11	1100	590	900	590	300	3-phase
NRA 400/..	650 or 950	NR 400/11	1100	590	1250	590	400	3-phase
NRA 500/..	650 or 950	NR 500/11	1100	720	1000	720	500	3-phase
NRA 700/..	650 or 950	NR 700/11	1100	720	1350	720	700	3-phase
NRA 1000/..	650 or 950	NR 1000/11	1100	870	1350	870	1000	3-phase

\*Please see page 60 for more information about supply voltage



## Cold-Wall Retort Furnaces up to 2400 °C or up to 3000 °C

### SVHT 2/24-W - SVHT 9/30-GR

Compared with the VHT models (page 54 ff), the retort furnaces of the SVHT product line offer improved performance data with regard to achievable vacuum and maximum temperature. Due to the design as pit-type furnace with tungsten heating, processes up to max. 2400 °C even in high vacuum can be implemented with models of the SVHT.-W product line. Models of the SVHT.-GR product line with graphite heating, also in pit-type design, can be operated in an inert gas atmosphere even up to max. 3000 °C.

- Standard sizes with a furnace chamber of 2 or 9 liters
- Designed as pit-type furnace, charged from above
- Frame construction with inserted sheets of textured stainless steel
- Dual shell water-cooled stainless steel container
- Manual operation of process gas and vacuum functions
- Manual gas supply for non-combustible process gas
- A step in front of the furnace for an ergonomic charging height
- Retort lid with gas-charged shock absorbers
- Controls and switchgear as well as gas supply integrated in furnace housing
- Defined application within the constraints of the operating instructions
- Further standard product characteristics see description for standard design of VHT models page 54



SVHT 9/24-W with tungsten heating

## Heating Options

### SVHT ..-GR

- Applicable for processes:
  - under protective or reaction gases or in the vacuum up to 2200 °C under consideration of relevant max. temperature limits
  - under inert gases (argon, helium) up to 3000 °C
- Max. vacuum up to 10<sup>-4</sup> mbar depending on the type of pump used
- Heating: graphite heating elements in cylindrical arrangement
- Insulation: graphite felt insulation
- Temperature measurement by means of an optical pyrometer



Graphite heating module

### SVHT ..-W

- Applicable for processes under protective or reaction gases or in vacuum up to 2400 °C
- Max. vacuum up to 10<sup>-5</sup> mbar depending on the type of pump used
- Heating: cylindrical tungsten heating module
- Insulation: tungsten and molybdenum radiant plates
- Temperature measurement with thermocouple type C



Cylindrical retort with tungsten heating

Additional equipment such as automatic process gas control or design for the operation with flammable gases incl. safety system see VHT models page 54.

Model	T <sub>max</sub> °C	Work space dimensions Ø x h in mm	Useful volume in l	Outer dimensions in mm			Heating power in kW <sup>1</sup>	Electrical connection*
				W	D	H		
SVHT 2/24-W	2400	150 x 150	2,5	1300	2500	2000	55	3-phase
SVHT 9/24-W	2400	230 x 230	9,5	1400	2900	2100	95	3-phase
SVHT 2/30-GR	3000	150 x 150	2,5	1400	2500	2100	65	3-phase
SVHT 9/30-GR	3000	230 x 230	9,5	1500	2900	2100	115	3-phase

<sup>1</sup>Depending on furnace design connected load might be higher

\*Please see page 60 for more information about supply voltage



Cooling water distribution



## Cold-Wall Retort Furnaces up to 2400 °C



VHT 500/22-GR H<sub>2</sub> with CFC-process box and extension package for operation under hydrogen

### VHT 8/18-GR - VHT 500/18-KE

The compact furnaces of the VHT product line are available as electrically heated chamber furnaces with graphite, molybdenum, tungsten or MoSi<sub>2</sub> heating. A wide variety of heating designs as well as a complete range of accessories provide for optimal retort furnace configurations even for sophisticated applications.

The vacuum-tight retort allows heat treatment processes either in protective and reaction gas atmospheres or in a vacuum, subject to the individual furnace specs to 10<sup>-5</sup> mbar. The basic furnace is suited for operation with non-flammable protective or reactive gases or under vacuum. The H<sub>2</sub> version provides for operation under hydrogen or other flammable gases. Key of the specification up is a certified safety package providing for a safe operation at all times and triggers an appropriate emergency program in case of failure.

### Alternative Heating Specifications

In general the following variants are available with respect to the process requirements:

#### VHT ...-GR with Graphite Insulation and Heating

- Suitable for processes under protective and reaction gases or under vacuum
- Tmax 1800 °C or 2200 °C (2400 °C as additional equipment)
- Max. vacuum up to 10<sup>-4</sup> mbar depending on pump type used
- Graphite felt insulation

#### VHT ...-MO or ...-W with Molybdenum or Tungsten Heating

- Suitable for high-purity processes under protective and reaction gases or under high vacuum
- Tmax 1200 °C, 1600 °C or 1800 °C (see table)
- Max. vacuum up to 10<sup>-5</sup> mbar depending on pump type used
- Insulation made of molybdenum resp. tungsten radiation sheets

#### VHT ...-KE with Fiber Insulation and Heating through Molybdenum Disilicide Heating Elements

- Suitable for processes under protective and reaction gases, in air or under vacuum
- Tmax 1800 °C
- Max. vacuum up to 10<sup>-2</sup> mbar (up to 1300 °C) depending on pump type
- Insulation made of high purity aluminum oxide fiber



VHT 8/18-KE with fiber insulation and molybdenum disilicide heating elements



Heat treatment of copper bars under hydrogen in VHT 8/16-MO

## Standard Equipment for all Models

### Basic version

- Standard furnace sizes 8 - 500 liters
- A water-cooled stainless steel process reactor sealed with temperature-resistant o-rings
- Frame made of stable steel profiles, easy to service due to easily removable stainless steel panels
- Housing of the VHT 8 model on castors for easy repositioning of furnace
- Cooling water manifold with manual stopcocks in supply and return lines, automatic flowmeter monitoring, openloop cooling water system
- Adjustable cooling water circuits with flowmeter and temperature indicator and overtemperature fuses
- Switchgear and controller integrated in furnace housing
- H 700 process control with clearly laid out 7" touchpanel control for program entry and display, 10 programs each with 20 segments
- Over-temperature limiter with adjustable cutout temperature for thermal protection class in accordance with EN 60519-2
- Manual operation of the process gas and vacuum functions
- Manual gas supply for one process gas (N<sub>2</sub> or Ar) with adjustable flow
- Bypass with manual valve for rapid filling or flooding of furnace chamber
- Manual gas outlet with overflow valve (20 mbar relative) for over-pressure operation
- Single-stage rotary vane pump with ball valve for pre-evacuating and heat treatment in a rough vacuum to 5 mbar
- Pressure gauge for visual pressure monitoring
- Defined application within the constraints of the operating instructions

### Additional equipment

- Tmax 2400 ° for VHT 40/..-GR and larger
- Housing, optionally divisible, for passing through narrow door frames (VHT 8)
- Manual gas supply for second process gas (N<sub>2</sub> or Ar) with adjustable flow and bypass
- Inner process box made of molybdenum, tungsten, graphite or CFC, especially recommended for debinding processes. The box is installed in the furnace with direct gas inlet and outlet and provides for better temperature uniformity. Generated exhaust gases will be directly lead out the inner process chamber during debinding. The change of gas inlet pathes after debinding results in a cleaned process gas atmosphere during sintering.
- Charge thermocouple with display
- Temperature measurement at 2200 °C models with pyrometer and thermocouple, type S with automatic pull-out device for precise control results in the low temperature range (VHT 40/..-GR and larger)
- Two-stage rotary vane pump with ball valve for pre-evacuating and heat-treating in a fine vacuum (up to 10<sup>2</sup> mbar)
- Turbo molecular pump with slide valve for pre-evacuation and for heat treatment in a high vacuum (up to 10<sup>5</sup> mbar) including electric pressure transducer and booster pump
- Other vacuum pumps on request
- Heat exchanger with closed-loop cooling water circuit
- Automation package with process control H 3700
  - 12" graphic touch panel
  - Input of all process data like temperatures, heating rates, gas injection, vacuum at the touch panel
  - Display of all process-relevant data on a process control diagram
  - Automatic gas supply for one process gas (N<sub>2</sub>, argon or forming gas) with adjustable flow
  - Bypass for flooding and filling the chamber with process gas controlled by the program
  - Automatic pre- and post programs, including leak test for safe furnace operation
  - Automatic gas outlet with bellows valve and overflow valve (20 mbar relative) for over-pressure operation
  - Transducer for absolute and relative pressure
- Mass flow controller for alternating volume flow and generation of gas mixtures with second process gas (only with automation package)
- Partial pressure operation: protective gas flushing at controlled underpressure (only with automation package)
- PC control via NCC with corresponding optional documentation and connection to customer PC networks



Graphite heating chamber



Molybdenum heating chamber



Tungsten heating chamber



Ceramic fiber insulation



Thermocouple, type S with automatic pull-out device for precise control results in the low temperature range



VHT 40/22-GR with motor-driven lift door and front frame for connection to a glovebox



VHT 40/16-MO H<sub>2</sub>

### H<sub>2</sub> Version for Operation with Hydrogen or other Reaction Gases

In the H<sub>2</sub> version the retort furnaces can be operated under hydrogen or other reaction gases. For these applications, the systems are additionally equipped with the required safety technology. Only certified and industry proven safety sensors are used. The furnaces are controlled by a fail-safe PLC control system (S7-300F/safety controller).



Turbo-molecular pump

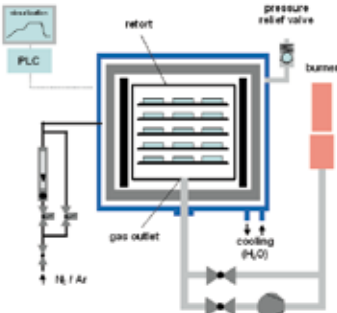

VHT gas supply diagram, debinding and sintering

- Certified safety concept
- Automation package (see additional equipment above)
- Redundant gas inlet valves for hydrogen
- Monitored pre-pressures of all process gases
- Bypass for safe purging of furnace chamber with inert gas
- Pressure-monitored emergency flooding with automated solenoid valve opening
- Electrically heated or gas-fired exhaust gas torch for H<sub>2</sub> post-combustion
- Atmospheric operation: H<sub>2</sub>-purging of process reactor starting from room temperature at controlled over pressure (50 mbar relative)

#### Additional equipment

- Partial pressure operation: H<sub>2</sub> flushing at underpressure in the process reactor starting from 750 °C furnace chamber temperature
- Inner process hood in the process chamber for debinding under hydrogen



Single-stage rotary vane pump for heat treatment in a rough vacuum to 5 mbar



Two-stage rotary vane pump for heat treatment in a vacuum to 10<sup>-2</sup> mbar



Turbo-molecular pump with booster pump for heat treatment in a vacuum to 10<sup>-5</sup> mbar

### Process Box for Debinding in Inert Gas

Certain processes require charges to be debinded in non-flammable protective or reactive gases. For these processes we fundamentally recommend a hot-wall retort furnace (see models NR... or SR...). These furnaces can ensure that the formation of condensation will be avoided as thoroughly as possible.

If there is no way to avoid the escape of small amounts of residual binder during the process, even in the VHT furnace, the retort furnace should be designed to meet this contingency.

The furnace chamber is equipped with an additional process box that has a direct outlet to the exhaust gas torch through which the exhaust gas can be directly vented. This system enables a substantial reduction in the amount of furnace chamber contamination caused by the exhaust gases generated during debinding.

Depending on the exhaust gas composition the exhaust gas line can be designed to include various options.

- Exhaust gas torch for burning off the exhaust gas
- Condensation trap for separating out binding agents
- Exhaust gas post-treatment, depending on the process, via scrubbers
- Heated exhaust gas outlet to avoid condensation deposits in the exhaust gas line



	VHT .../...-GR	VHT .../...-MO	VHT .../18-W	VHT .../18-KE
Tmax	1800 °C or 2200 °C	1200 °C or 1600 °C	1800 °C	1800 °C
Inert gas	✓	✓	✓	✓
Air/Oxygen	-	-	-	✓
Hydrogen	✓ <sup>3,4</sup>	✓ <sup>3</sup>	✓ <sup>3</sup>	✓ <sup>1,3</sup>
Rough vacuum and fine vacuum (>10 <sup>-3</sup> mbar)	✓	✓	✓	✓ <sup>2</sup>
High vacuum (<10 <sup>-3</sup> mbar)	✓ <sup>4</sup>	✓	✓	✓ <sup>2</sup>
Material of heater	Graphite	Molybdenum	Tungsten	MoSi <sub>2</sub>
Material of insulation	Graphite felt	Molybdenum	Tungsten/Molybdenum	Ceramic fiber

VHT 8/16-MO with hydrogen extension package and process box

<sup>1</sup>Tmax reduces to 1400 °C

<sup>2</sup>Depending on Tmax

<sup>3</sup>Only with safety package for flammable gases

<sup>4</sup>Up to 1800 °C

Model	Inner dimensions of process box in mm			Volume in l
	w	d	h	
VHT 8/..	120	210	150	3,5
VHT 40/..	250	430	250	25,0
VHT 70/..	325	475	325	50,0
VHT 100/..	425	500	425	90,0
VHT 250/..	575	700	575	230,0
VHT 500/..	725	850	725	445,0

Model	Inner dimensions in mm			Volume in l	Max. charge weight/kg	Outer dimensions in mm			Heating power in kW <sup>4</sup>			
	w	d	h			W	D	H	Graphite	Molybdenum	Tungsten	Ceramic fiber
VHT 8/..	170	240	200	8	5	1250 (800) <sup>1</sup>	1100	2000	27	19/34 <sup>3</sup>	50	12
VHT 40/..	300	450	300	40	30	1600	2100	2300	83/103 <sup>2</sup>	54/60 <sup>3</sup>	90	30
VHT 70/..	375	500	375	70	50	1700	2500	2400	105/125 <sup>2</sup>	70/100 <sup>3</sup>	150	55
VHT 100/..	450	550	450	100	75	1900	2600	2500	131/155 <sup>2</sup>	90/140 <sup>3</sup>	on request	85
VHT 250/..	600	750	600	250	175	3000 <sup>1</sup>	4300	3100	180/210 <sup>2</sup>	on request	on request	on request
VHT 500/..	750	900	750	500	350	3200 <sup>1</sup>	4500	3300	220/260 <sup>2</sup>	on request	on request	on request

<sup>1</sup>With separated switching system unit

<sup>2</sup>1800 °C/2200 °C

<sup>3</sup>1200 °C/1600 °C

<sup>4</sup>Depending on furnace design connected load might be higher



## Catalytic and Thermal Afterburning Systems, Exhaust Gas Washer



Exhaust gas washer to clean generated process gases by washing out



Standard laboratory muffle furnace L 5/11 with catalyst KAT 50 see page 12

### Catalytic and Thermal Afterburning Systems (KNV and TNV), Exhaust Gas Washer

For exhaust gas cleaning, in particular in debinding, Nabertherm offers exhaust gas cleaning systems tailored to the process. The afterburning system is permanently connected to the exhaust gas fitting of the furnace and accordingly integral part of the control system and the safety matrix of the furnace. For existing furnaces, independent exhaust gas cleaning systems are also available that can be separately controlled and operated.

Catalytic exhaust cleaning is especially recommended due to energetic reasons when only pure hydrocarbon compounds must be cleaned during the debinding process in air. Thermal afterburning systems are used if large volumes of exhaust gas from the debinding process in air must be cleaned and/or if there is a risk that the exhaust gases might damage the catalyst. Thermal afterburning is also used for debinding applications under non-flammable or flammable protective or reaction gases.

An exhaust gas washer is often used if large amounts of exhaust gases are generated respectively, if the gases cannot be treated with a thermal afterburner system or with a torch. The gases will be lead through a water shower and fall out as condensate.

#### Catalytic afterburning systems (KNV)

- Perfectly suited for debinding processes in air with only organic exhaust gases
- Catalytic conversion of the unburned hydrocarbons to their nontoxic, natural components
- Integrated in a compact stainless steel housing
- Electric heating provides for preheating of the exhaust gas to the optimal reaction temperature for catalytic treatment
- Cleaning in different layers of catalytic honeycombs within the system
- Thermocouples for measuring the temperatures of raw gas, reaction honeycombs and discharge
- Over-temperature limiter with adjustable cutout temperature protects the catalyst
- Tight connection between the exhaust gas outlet of the debinding furnace and the exhaust gas fan with corresponding integration into the overall system with respect to control and safety technology
- Catalyst dimensioned in relation to the exhaust gas flow
- Measuring port for clean gas measurements (FID)

#### Thermal afterburning systems (TNV)

- Optimally suited for debinding processes in air with large exhaust gas flow, erratic large exhaust gas volumes, large volume flow or for debinding processes under non-flammable or flammable protective or reaction gases
- Burn-off at temperatures up to 850 °C provides for thermal decomposition of the exhaust gases
- Heating with compact gas burner with automatic firing device
- Thermocouples in the combustion chamber and in the raw gas inlet
- Over-temperature limiter for protecting the thermal afterburning
- Design depending on the exhaust gas flow
- Measuring port for clean gas measurements (FID)



Chamber furnace N 150/14 with catalytic afterburning system



Thermal afterburning system



## Temperature Uniformity and System Accuracy

Temperature uniformity is defined as the maximum temperature deviation in the work space of the furnace. There is a general difference between the furnace chamber and the work space. The furnace chamber is the total volume available in the furnace. The work space is smaller than the furnace chamber and describes the volume which can be used for charging.

### Specification of Temperature Uniformity in +/- K in the Standard Furnace

In the standard design the temperature uniformity is specified in +/- K at a defined set-temperature with the work space of the empty furnace during the dwell time. In order to make a temperature uniformity survey the furnace should be calibrated accordingly. As standard our furnaces are not calibrated upon delivery.

### Calibration of the Temperature Uniformity in +/- K

If an absolute temperature uniformity at a reference temperature or at a defined reference temperature range is required, the furnace must be calibrated appropriately. If, for example, a temperature uniformity of +/- 5 K at a set temperature of 750 °C is required, it means that measured temperatures may range from a minimum of 745 °C to a maximum of 755 °C in the work space.

### System Accuracy

Tolerances may occur not only in the work space, they also exist with respect to the thermocouple and in the controls. If an absolute temperature uniformity in +/- K at a defined set temperature or within a defined reference working temperature range is required, the following measures have to be taken:

- Measurement of total temperature deviation of the measurement line from the controls to the thermocouple
- Measurement of temperature uniformity within the work space at the reference temperature or within the reference temperature range
- If necessary, an offset is set at the controls to adjust the displayed temperature at the controller to the real temperature in the furnace
- Documentation of the measurement results in a protocol

### Temperature Uniformity in the Work Space incl. Protocol

In standard furnaces a temperature uniformity is guaranteed as +/- K without measurement of temperature uniformity. However, as additional feature, a temperature uniformity measurement at a reference temperature in the work space compliant with DIN 17052-1 can be ordered. Depending on the furnace model, a holding frame which is equivalent in size to the work space is inserted into the furnace. This frame holds thermocouples at 11 defined measurement positions. The measurement of the temperature uniformity is performed at a reference temperature specified by the customer at a pre-defined dwell time. If necessary, different reference temperatures or a defined reference working temperature range can also be calibrated.



Holding frame for measurement of temperature uniformity



Pluggable frame for measurement for air circulation chamber furnace N 7920/45 HAS



The system accuracy is defined by adding the tolerances of the controls, the thermocouple and the work space

Precision of the controls, e.g. +/- 1 K

Deviation of thermocouple, e.g. +/- 1.5 °C

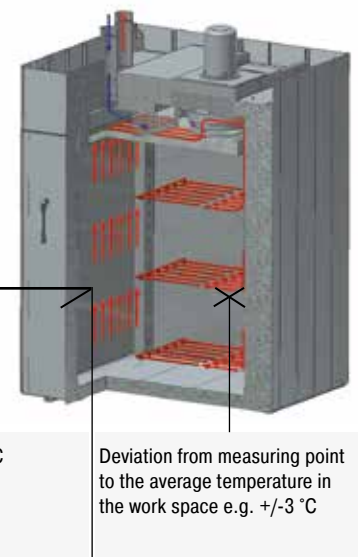

Deviation from measuring point to the average temperature in the work space e.g. +/- 3 °C



B 400/C 440/ P 470



B 410/C 450/P 480



H 1700 with colored, tabular depiction



H 3700 with colored graphic presentation

## Process Control and Documentation

Nabertherm has many years of experience in the design and construction of both standard and custom control alternatives. All controls are remarkable for their ease of use and even in the basic version have a wide variety of functions.

### Standard Controllers

Our extensive line of standard controllers satisfies most customer requirements. Based on the specific furnace model, the controller regulates the furnace temperature reliably. The standard controllers are developed and fabricated within the Nabertherm group. When developing controllers, our focus is on ease of use. From a technical standpoint, these devices are custom-fit for each furnace model or the associated application. From the simple controller with an adjustable temperature to the control unit with freely configurable control parameters, stored programs, PID microprocessor control with self-diagnosis system and a computer interface, we have a solution to meet your requirements.

### HiProSystems Control and Documentation

This professional process control with PLC controls for single and multi-zone furnaces is based on Siemens hardware and can be adapted and upgraded extensively. HiProSystems control is used when more than two process-dependent functions, such as exhaust air flaps, cooling fans, automatic movements, etc., have to be handled during a cycle, when furnaces with more than one zone have to be controlled, when special documentation of each batch is required and when remote telediagnostic service is required. It is flexible and is easily tailored to your process or documentation needs.

### Alternative User Interfaces for HiProSystems

#### Process control H 500/H 700

This basic panel accommodates most basic needs and is very easy to use. Firing cycle data and the extra functions activated are clearly displayed in a table. Messages appear as text. Data can be stored on a USB stick using the „NTLog Comfort“ option (not available for all H 700).

#### Process control H 1700

Customized versions can be realized in addition to the scope of services of the H 500/H 700

#### Process control H 3700

Display of functions on a large 12" display. Display of basic data as online trend or as a graphical system overview. Scope as H 1700

### Control, Visualisation and Documentation with Nabertherm Control Center NCC

Upgrading the HiProSystems-Control individually into a PC-based NCC provides for additional interfaces, operating documentation, and service benefits in particular for controlling furnace groups including charge beyond the furnace itself (quenching tank, cooling station etc.):

- Recommended for heat treatment processes with extensive requirements in respect to documentation e.g. for metals, technical ceramics or in the medicine field
- Software extension can be used also in accordance with the AMS 2750 E (NADCAP)
- Documentation according to the requirements of Food and Drug Administration (FDA), Part 11, EGV 1642/03 possible
- Charge data can be read in via barcodes
- Interface for connection to overriding systems
- Connection to mobile phone or stationary network for malfunction message transmission via SMS
- Control from various locations over the network
- Measurement range calibration up to 18 temperatures per measuring point for use at different temperatures. For norm-relevant applications a multilevel calibration is possible.

### Assignment of Standard Controllers to Furnace Families

	L1/12	L3 - LT 40	LE 1/11 + LE 2/11	LE 6/11 + LE 14/11	LV, LVT	L 9/11/SKM	L(T) 9/.../SW	N .. CUP	N 7/H - N 87/H	LH 15/12 - LF 120/14	HTCT	LHT ..../(D)	LHT 02/17 LB + LHT 16/17 LB	LHT 04/16 SW + LHT 04/17 SW	HT	HTC 16/16 - HTC 450/16	HFL	TR	N 15/65 HA	NA 30/45 - N 500/85 HA	RD	R	RT	RHTC	RHTH/RHTV	RS	RSRB, RSRC	K	KC	LS	GR	NRA 17/06 - NRA 1000/11	NR, NRA .. H <sub>2</sub>	NR, NRA .. IDB	SVHT	VHT	
Catalog page	4	4,7	6	6	8	10	11	13	14	16	18	19	20	21	22	24	25	26	28	28	30	31	32	33	34	36	38	48	48	49	49	50	52	52	53	54	
Controller																																					
B 180		● <sup>1</sup>			● <sup>1</sup>	● <sup>1</sup>	● <sup>1</sup>				● <sup>1</sup>						○	○	● <sup>1</sup>			● <sup>1</sup>	○	○													
P 330		○			○	○	○				○							○	○			○	○	○													
R 7	●		●															●			●																
C 6/3208																																					
B 150				●					● <sup>1</sup>	● <sup>1</sup>															● <sup>1</sup>	● <sup>1</sup>											
P 300				○				● <sup>1</sup>	○	○															○	○											
P 310									○	○		● <sup>1</sup>	● <sup>1</sup>	● <sup>1</sup>	● <sup>1</sup>	● <sup>1</sup>	● <sup>1</sup>							● <sup>1</sup>													
3216	○		○																		○																
3504								○																													
B 400								● <sup>1</sup>	● <sup>1</sup>	● <sup>1</sup>															● <sup>1</sup>	● <sup>1</sup>											
B 410		● <sup>1</sup>			● <sup>1</sup>	● <sup>1</sup>	● <sup>1</sup>		● <sup>1</sup>	● <sup>1</sup>	● <sup>1</sup>							○	● <sup>1</sup>			● <sup>1</sup>	● <sup>1</sup>	● <sup>1</sup>		● <sup>1</sup>	● <sup>1</sup>										
C 440									○	○																											
C 450		○			○	○	○		○	○																											
P 470									○	○		● <sup>1</sup>	● <sup>1</sup>	● <sup>1</sup>	● <sup>1</sup>	● <sup>1</sup>	● <sup>1</sup>				● <sup>1</sup>				● <sup>1</sup>												
P 480		○			○	○	○																														
H 500/PLC															○	○	○																				
H 700/PLC															○	○	○																				
H 1700/PLC															○	○	○																				
H 3700/PLC															○	○	○																				

<sup>1</sup> Depending on the design

### Functionality of the Standard Controllers

	R6	C6	3216	3208	B130	B150	B180	B400/ B410	C280	C440/ C450	P300	P310	P330	P470/ B480	3504	H500	H700	H1700	H3700	NCC
Number of programs	1	1	1		2	1	1	5	9	10	9	9	9	50	25	20	1/10 <sup>4</sup>	10	10	50
Segments	1	2	8		3	2	2	4	3	20	40	40	40	40	500 <sup>4</sup>	20	20	20	20	20
Extra functions (e.g. fan or autom. flaps)								2	2	2	2 <sup>3</sup>	2 <sup>3</sup>	2	2-6	2-8 <sup>4</sup>	3 <sup>4</sup>	○ <sup>4</sup>	6/2 <sup>4</sup>	8/2 <sup>4</sup>	16/4 <sup>4</sup>
Maximum number of control zones	1	1	1	1	1	1	1	1	1	1	1	1	1	3	2 <sup>2</sup>	1-3 <sup>4</sup>	○ <sup>4</sup>	8	8	8
Drive of manual zone regulation								●		●			●	●						
Charge control/bath control														●						
Auto tune			●	●	●	●	●	●	●	●	●	●	●	●	○	○	○	○	○	○
Real-time clock								●	●	●	●	●	●	●	●	●	●	●	●	●
Plain, blue-white LC-display					●	●	●	●	●	●	●	●	●	●	●	●	●	●	●	●
Graphic color display																	4"7"	7"	7"	12"
Status messages in clear text				●	●	●	●	●	●	●	●	●	●	●	●	●	●	●	●	●
Data input via number pad							●				●	●	●	●	●	●	●	●	●	●
Data entry via touchpanel								●			●	●	●	●	●	●	●	●	●	●
Data entry via jog wheel and buttons								●			●	●	●	●	●	●	●	●	●	●
Entering program names (i.e. "Sintering")								●			●	●	●	●	●	●	●	●	●	●
Keypad lock					●	●		●	●	●	●	●	●	●	●	●	●	●	●	●
User administration								●	●	●	●	●	●	●	●	○	○	○	○	●
Skip-button for segment jump								●	●	●	●	●	●	●	●	●	●	●	●	●
Program entry in steps of 1 °C or 1 min.	●		●	●	●	●	●	●	●	●	●	●	●	●	●	●	●	●	●	●
Start time configurable (e.g. to use night power rates)					●	●	●	●	●	●	●	●	●	●	●	●	●	●	●	●
Switch-over °C/°F	○		○	○	●	●	●	●	●	●	●	●	●	●	○	●	● <sup>4</sup>	● <sup>4</sup>	● <sup>4</sup>	● <sup>4</sup>
kWh meter					●	●	●	●	●	●	●	●	●	●	●	●	●	●	●	●
Operating hour counter					●	●	●	●	●	●	●	●	●	●	●	●	●	●	●	●
Programmable power outlet													● <sup>5</sup>							
Real-time clock				○				●		●				●	○					
Set point output																				
NTLog Comfort for HiProSystems: Recording of process data on an external storage medium					○	○	○	●	○	●	○	○	○	○	●					
NTLog Basic for Nabertherm Controller: Recording of process data with USB-flash drive					○	○	○	○	○	○	○	○	○	○	○					
Interface for MV software					○	○	○	○	○	○	○	○	○	○	○					

<sup>1</sup> Not for melt bath control

<sup>2</sup> Control of additional separate slave regulators possible

<sup>3</sup> As an extra feature in air circulation furnaces

<sup>4</sup> Depending on the design

<sup>5</sup> Not for model L(T)15..

● Standard  
○ Option

## Mains Voltages for Nabertherm Furnaces

1-phase: all furnaces are available for mains voltages from 110 V - 240 V at 50 or 60 Hz.

3-phase: all furnaces are available for mains voltages from 200 V - 240 V or 380 V - 480 V, at 50 or 60 Hz.

The connecting rates in the catalog refer to the standard furnace with 400 V (3/N/PE) respectively 230 V (1/N/PE).

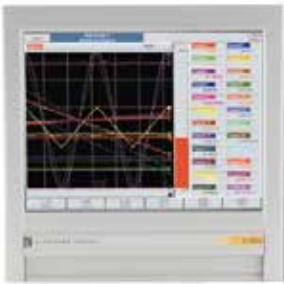

Temperature recorder

### Temperature Recorder

Besides the documentation via the software which is connected to the controls, Nabertherm offers different temperature recorders which can be used with respect to the application.

	Model 6100e	Model 6100a	Model 6180a
Data input using touch panel	x	x	x
Size of colour display in inch	5.5	5.5	12.1
Number of thermocouple inputs	3	18	48
Data read-out via USB-stick	x	x	x
Input of charge data		x	x
Evaluation software included	x	x	x
Applicable for TUS-measurements acc. to AMS 2750 E			x



### Data storing of Nabertherm controllers with NTLog Basic

NTLog Basic allows for recording of process data of the connected Nabertherm Controller (B 400, B 410, C 440, C 450, P 470, P480) on a USB stick.

The process documentation with NTLog Basic requires no additional thermocouples or sensors. Only data recorded which are available in the controller.



The data stored on the USB stick (up to 80,000 data records, format CSV) can afterwards be evaluated on the PC either via NTGraph or a spreadsheet software used by the customer (e.g. MS Excel).

For protection against accidental data manipulation the generated data records contain checksums.



NTLog Comfort for data recording of a Siemens PLC

### Data storing of HiProSystems with NTLog Comfort

The extension module NTLog Comfort offers the same functionality of NTLog Basic module. Process data from a HiProSystems control are read out and stored in real time on a USB stick (not available for all H 700 systems). The extension module NTLog Comfort can also be connected using an Ethernet connection to a computer in the same local network so that data can be written directly onto this computer.

### Visualization with NTGraph

The process data from NTLog can be visualized either using the customer's own spreadsheet program (e.g. MS-Excel) or NTGraph (Freeware). With NTGraph Nabertherm provides for a user-friendly tool free of charge for the visualization of the data generated by NTLog. Prerequisite for its use is the installation of the program MS Excel for Windows (version 2003/2010/2013). After data import presentation as diagram, table or report can be chosen. The design (color, scaling, reference labels) can be adapted by using prepared sets.

NTGraph is available in seven languages (DE/EN/FR/SP/IT/CH/RU). In addition, selected texts can be generated in other languages.

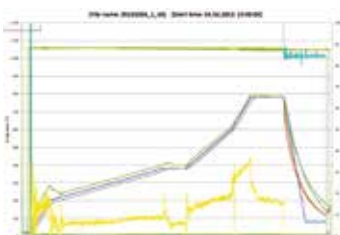

NTGraph, a freeware for the easy-to-read analysis of recorded data using MS Excel

**Controltherm MV Software for Control, Visualisation and Documentation**

Documentation and reproducibility gain increased attention with steadily rising quality standards. The powerful Nabertherm software Controltherm MV provides for an optimum solution for the control and documentation of one or more furnaces as well as charge data on basis of Nabertherm controllers.

In the basic version one furnace can be connected to the MV-software. The system can be extended to 16 multi-zone controlled furnaces. Up to 400 different heat treatment programs can be stored. The process will be documented and filed. Process data can be read-out graphically or in table format. A data transfer to MS-Excel is also possible.

For furnaces which are not controlled via a Nabertherm controller, the furnace temperature can be documented with the MV-software. We deliver an extension package as optional equipment. With respect to the individual version, three, six or even nine independent thermocouples can be connected. Independent of the control system, the values of each thermocouple will be read-out and evaluated by the MV-software.



Controltherm MV Software for Control, Visualisation and Documentation

**Features**

- Simple installation without specific knowledge
- Available for controllers B 400/B 410/C 440/C 450/P 470/P 480
- Suitable for PC with operating system Microsoft Windows 8/8.1 (32/64 Bit), Windows 7 (32/64 Bit), XP with SP3
- All Nabertherm controllers with optional ethernet interface connectable
- Encoded storage of temperature curves of up to 16 furnaces (also multizone-controlled), depending on the version of MV-software
- Redundant storage on a network server possible
- Programming, archiving and printing of programs and graphics
- Free input of descriptive charge data text with comfortable search function
- Data exportable into Excel format for further evaluation
- Start/stop of the controller from the local PC
- Selectable languages: German, English, French, Italian or Spanish



Clear display of connected furnaces

**Extension Package II for Connection of one Additional Temperature Measuring Point, Independent of the Controller**

- Connection of an independent thermocouple, type K or S with display of the measured temperature on the included controller C 6 D, e.g. for documentation of charge temperature
- Conversion and transmission of measured data to the MV-software
- For data evaluation see MV-software features

**Extension Package II for Connection Three, Six or Nine Temperature Measuring Points, Independent of the Controller**

- Connection of three thermocouples, type K, S, N or B to the supplied connection box
- Extendable to two or three connection boxes for up to nine temperature measuring points
- Conversion and transmission of measured data to the MV-software
- For data evaluation, please see MV-software features



Graphical display of setpoint and actual values



Extendable for connection of up to 16 furnaces



## The whole World of Nabertherm: [www.nabertherm.com](http://www.nabertherm.com)

Please visit our website

[www.nabertherm.com](http://www.nabertherm.com) and find out all you want to know about us - and especially about our products.

Besides news and our current calendar of trade fairs, there is also the opportunity to get in touch directly with your local sales office or nearest dealer worldwide.

### Professional Solutions for:

- Arts & Crafts
- Glass
- Advanced Materials
- Laboratory
- Dental
- Thermal Process Technology for Metals, Plastics and Surface Finishing
- Foundry



## Headquarters:

### Nabertherm GmbH

Bahnhofstr. 20  
28865 Lilienthal, Germany  
[contact@nabertherm.de](mailto:contact@nabertherm.de)

## Sales and Service Subsidiaries:

### China

Nabertherm Ltd. (Shanghai)  
150 Lane, No. 158 Pingbei Road, Minhang District  
201109 Shanghai, China  
[contact@nabertherm-cn.com](mailto:contact@nabertherm-cn.com)

### France

Nabertherm SARL  
35 Allée des Impressionnistes - BP 44011  
95911 Roissy CDG Cedex, France  
[contact@nabertherm.fr](mailto:contact@nabertherm.fr)

### Italy

Nabertherm Italia  
via Trento N° 17  
50139 Florence, Italy  
[contact@nabertherm.it](mailto:contact@nabertherm.it)

### Great Britain

Nabertherm Ltd., United Kingdom  
[contact@nabertherm.com](mailto:contact@nabertherm.com)

### Switzerland

Nabertherm Schweiz AG  
Batterieweg 6  
4614 Hägendorf, Switzerland  
[contact@nabertherm.ch](mailto:contact@nabertherm.ch)

### Spain

Nabertherm España  
c/Marti i Julià, 8 Bajos 7ª  
08940 Cornellà de Llobregat, Spain  
[contact@nabertherm.es](mailto:contact@nabertherm.es)

### USA

Nabertherm Inc.  
54 Read's Way  
New Castle, DE 19720, USA  
[contact@nabertherm.com](mailto:contact@nabertherm.com)

## All other Countries: Follow

<http://www.nabertherm.com/contacts>